



Quarto

KIDS: NOVELTY

SPRING 2024 – CHINA

Q.

Box Kits

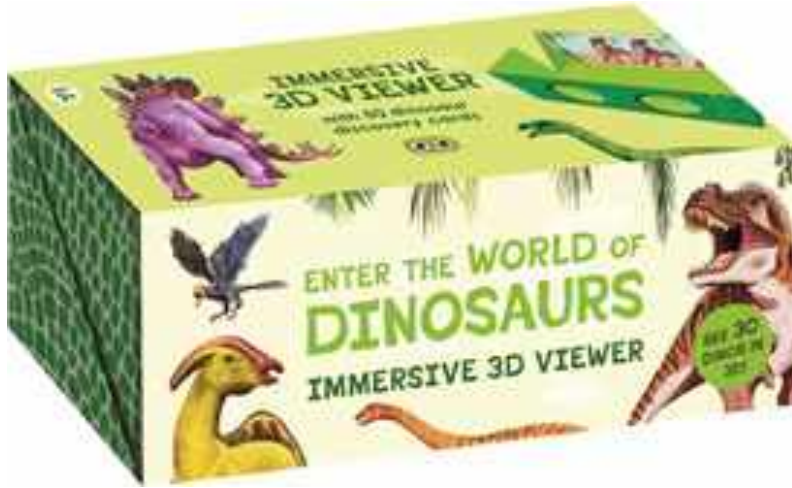

Enter the World of Dinosaurs – Immersive 3D Viewer

- **Incredible 3D dinosaur viewer:** See 30 illustrated dinosaurs in roar-some 3D
- **Screen-free fun** for dinosaur fans aged 3+
- **Learn through play:** Packed with fun facts and observation games
- **3D viewer box contains:** 3D lenses, cards featuring 30 dinosaur illustrations and fun facts, instruction and games leaflet; box size is 18 × 6.5 × 6.5 cm / 7 × 2.5 × 2.5 in.

Box 180 x 68 x 68mm, 30 cards, sleeve, box with lenses, platform

Translation files: available

UK RRP: £14.99



TRICERATOPS

Easy to recognize, with three horns and a fancy frill!

Triceratops lived at the same time as Tyrannosaurus and would have had to defend itself so it didn't get eaten.

In fact, scientists found part of a fossil Triceratops skull with a T.rex-sized bite taken out of one horn! As well as protecting its neck, scientists think Triceratops might have used its bony frill to make sure it didn't get too hot or cold, to tell each other apart and to impress other dinosaurs.



Herbivore



Late Cretaceous



9m (30ft)



5,500kg (12,130lb)



USA

Link to presentation/full pages:

[Enter the World of Dinosaurs](#)

Enter the World of Dinosaurs: Immersive 3D Viewer



Enter the World of Dinosaurs: Immersive 3D Viewer



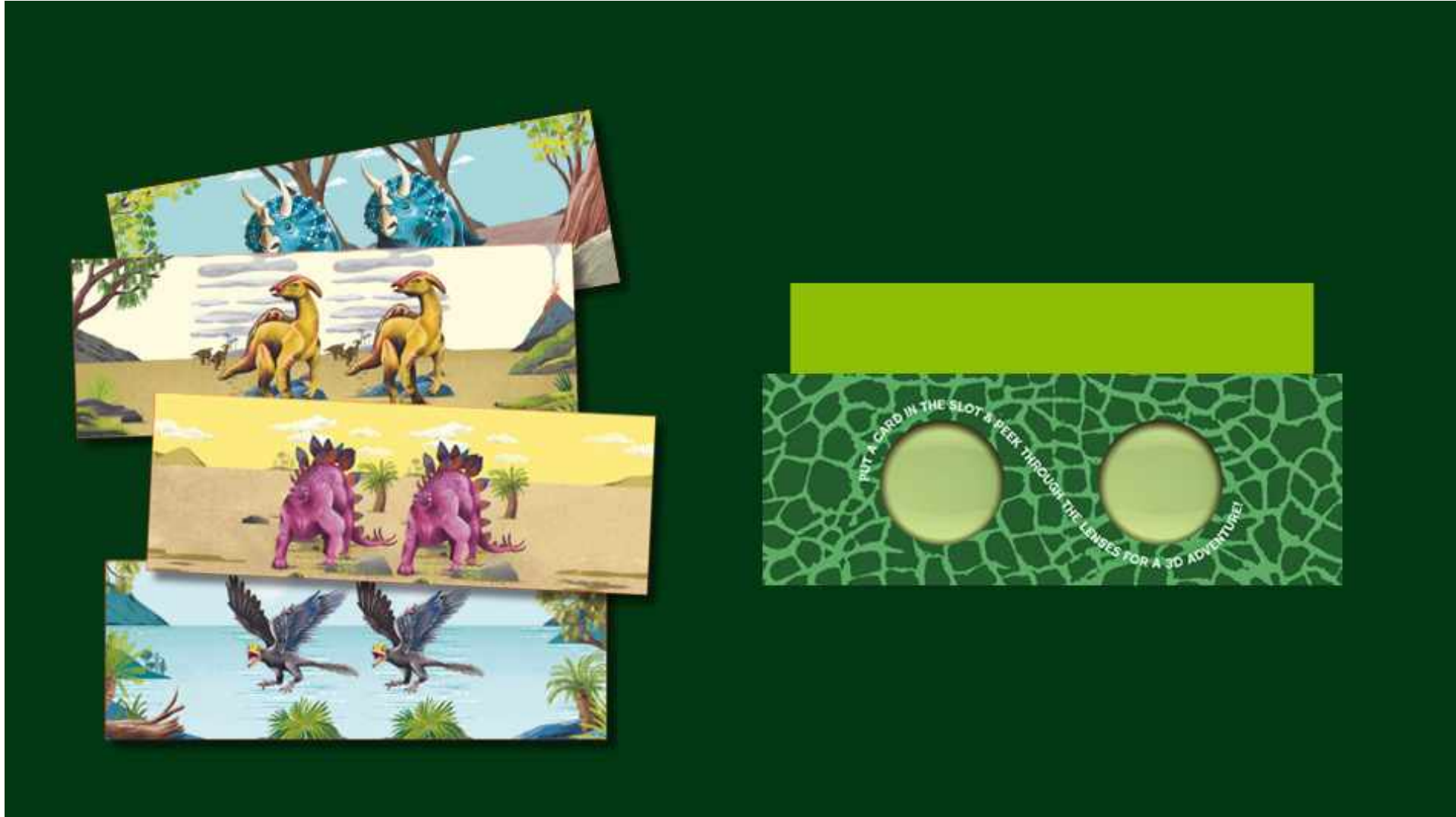





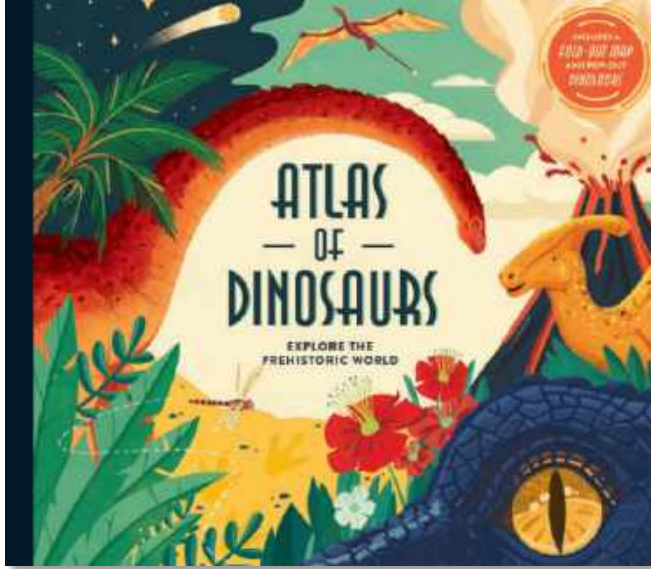

Atlas of Dinosaurs

Written by Kirsty Neale and illustrated by Ryan Johnson

- Discover everything you wanted to know about dinosaurs with this jam-packed box set bursting with dino facts and discoveries.
- Detailed full colour spreads explore the 170 million year evolution of the dinosaur
- Box set features: Double-sided play mat showing prehistoric scenes on one side, and high-quality maps of dinosaur discoveries on the other, stand-up dinosaur model pieces to populate play scenes.
- *Series Extensions:*
 - Atlas of Mythical Beasts
 - Atlas of the Universe

Extent: boxset + 64 page book

TPS (h x w): 260(h)mm X 230(w)mm

Translation files available: TBC

RRP: £24.99

Link to presentation/full pages:

[Atlas of Dinosaurs](#)

[Atlas of Dinosaurs - outline](#)



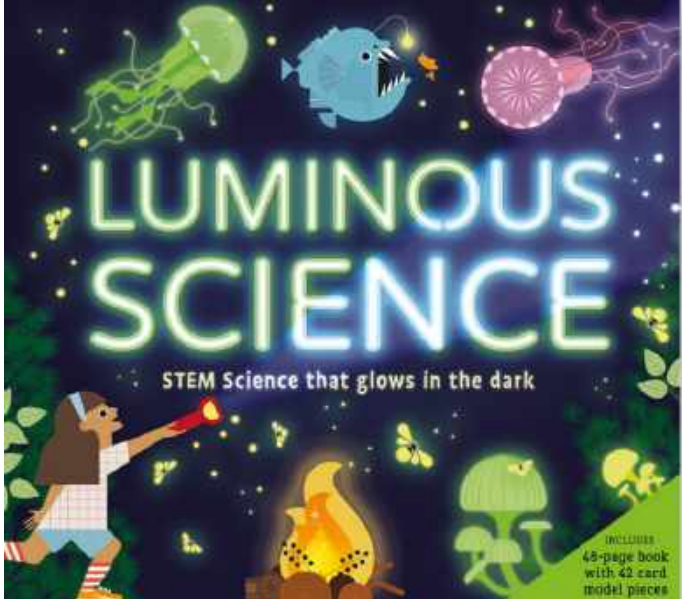

Luminous Science

Written by Kris Hirschmann and illustrated by Sally Caulwell

- This striking book explores the science of luminosity, if it produces light without heat, you'll find it here.
- From surprising substances that sparkle under UV light, to beautiful bioluminescent animals.
- Features a striking fluoro front cover, and includes model pieces for making hands-on science experiments such as a black-out box, fingerprint card, a glowing sign and a lava lamp, plus a UV torch and luminescent pens.

Extent: boxset + 48 pages

TPS (h x w): 230mm x 260mm

Translation files available: TBC

RRP: £18.99

Next co-edition schedule

File to printer: 01 August 2024

Delivery FOB HK: 01 December 2024

Link to presentation/full pages:

[Luminous science](#)

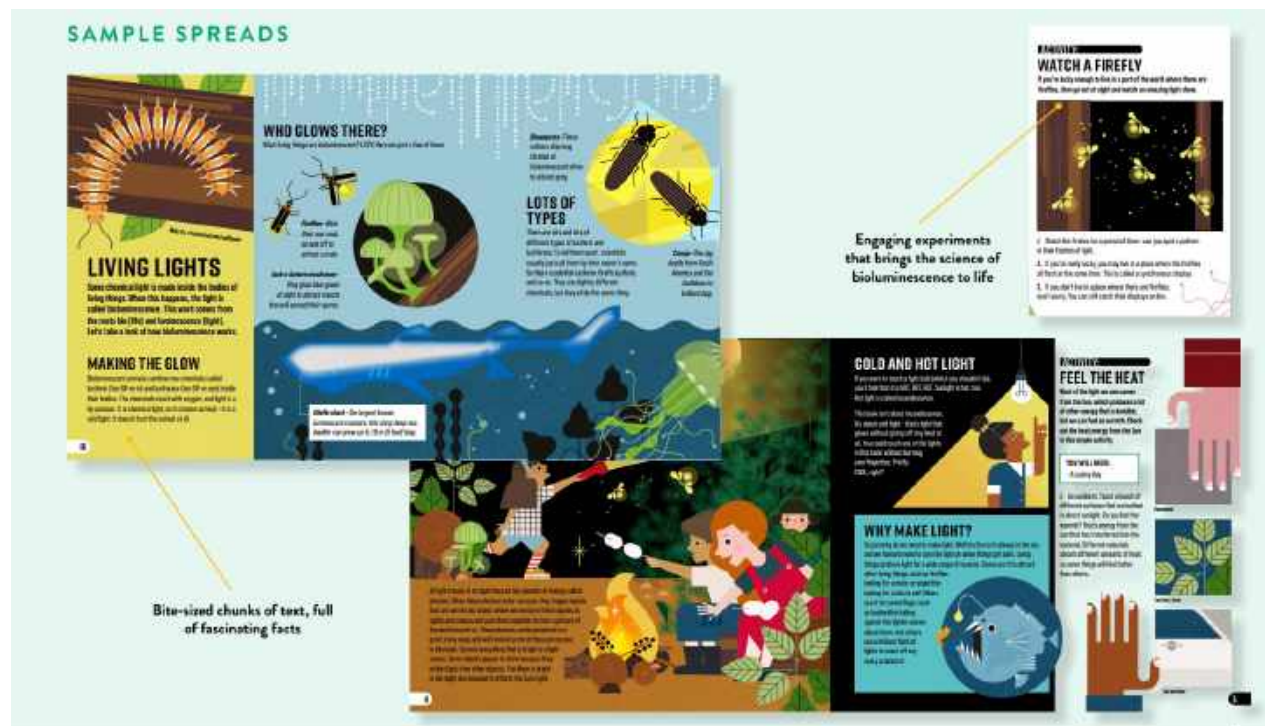

Engineer Academy: Moon Landing

Written by Dr Ben Miles and illustrated by Diego Vaisberg

- Discover what it takes to travel to – and live on – the Moon, with facts, experiments and six models to build
- No plastic: six fully card models to build – no scissors required
- Over 10 “Try This” projects to deepen learning with everyday objects
- Chapters include: Getting into Orbit, Life in Zero G, Living on the Moon, Mars and Beyond
- Perfectly timed for the upcoming Moon missions, the first crewed landings for over 50 years

Extent: boxset + 64 pages

TPS (h x w): 230mm x 260mm

Translation files available: **TBC**

RRP: £15.99

Next co-edition schedule

File to printer: 01 April 2024

Delivery FOB HK: 15 July 2024

Link to presentation/full pages:

[Engineer Academy - Mission to the Moon](#)

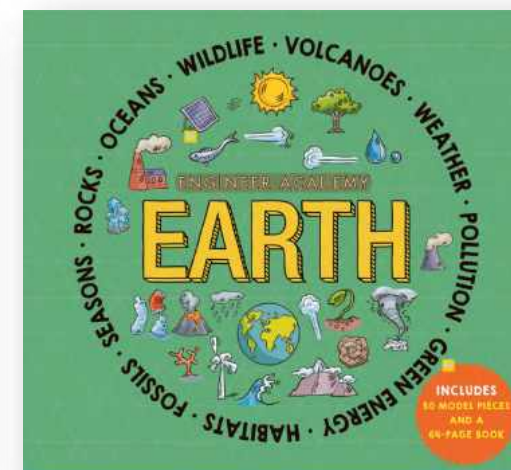
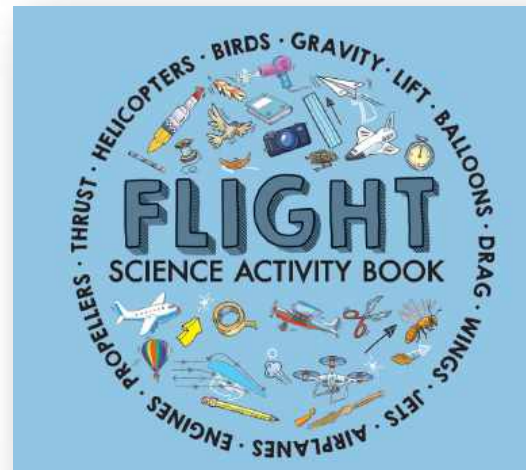

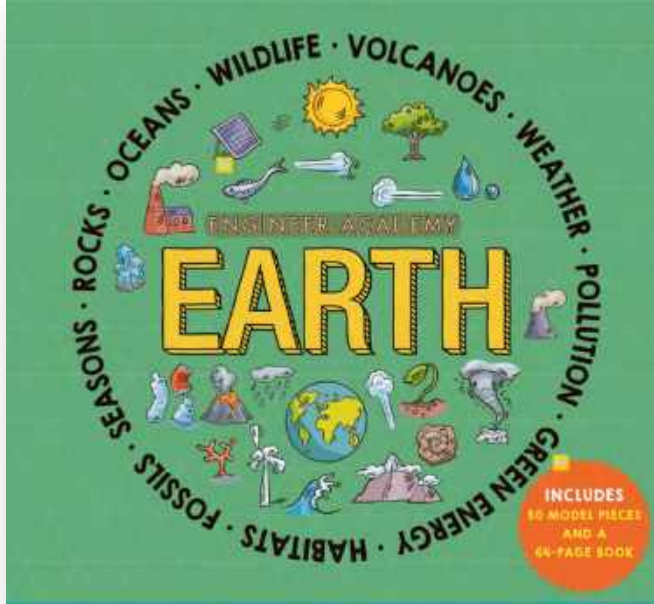

Engineer Academy: Earth

- Fantastic introduction to our planet, from tectonic plates and the water cycle, to habitats and solar power.
- Hands-on learning with 6 3D models to build, including a mobile of the solar system, a seismograph, Archimedes screw, weather station, spinning Earth model and a working solar oven.
- “Try This” projects to deepen learning with everyday objects.

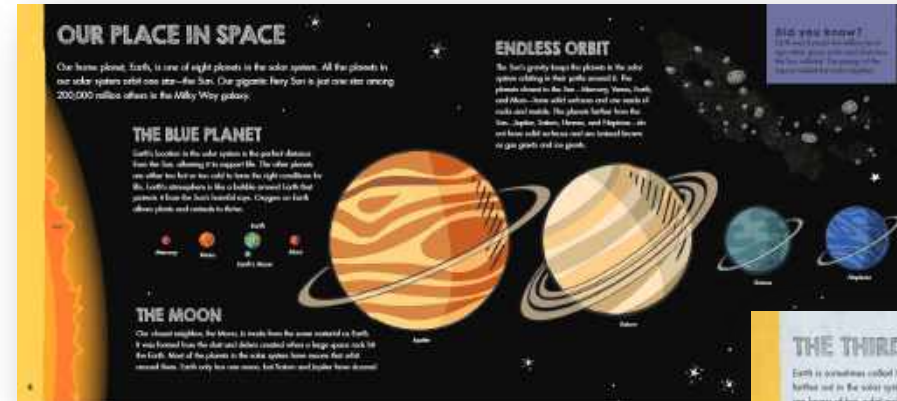

Extent: boxset + 64 pages

TPS (h x w): 230mm x 260mm

Translation files available: March 2023

RRP: £15.99

Link to presentation/full pages:

Earth Academy: [PDF](#) – [Earth model](#)

[Series A1](#)

Engineer Academy Flight

- Comes with 6 build-it-yourself projects to learn about the science of flight.
- From pterosaurs to wingsuits, curious kids will love learning everything about flight.
- Packed with experiments you can do with items from around the home.



Extent: boxset + 64 pages
 TPS (h x w): 230mm x 260mm
 Translation files available
 RRP: £15.99

Link to presentation/full pages:
[Engineer Academy Flight AI](#)
[Engineer Academy Flight PDF](#)
[Leonardo Da Vinci's Helicopter Model](#)

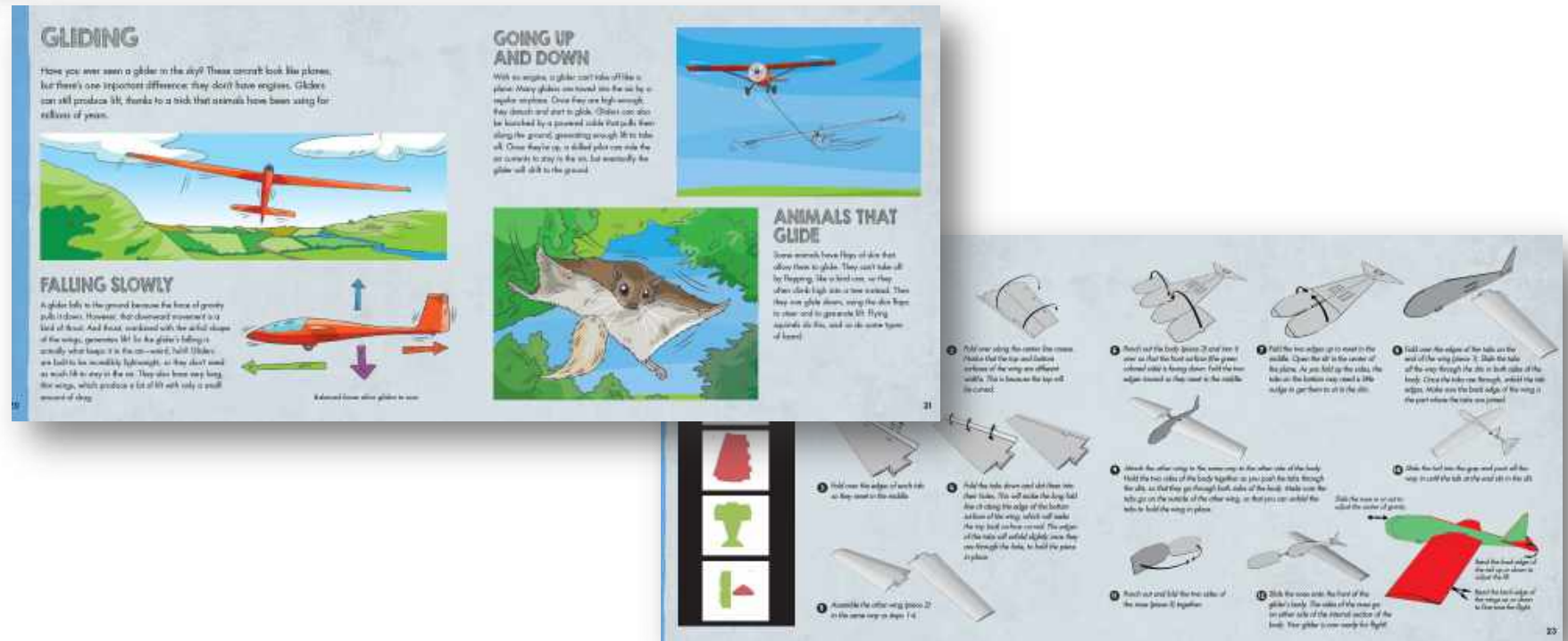

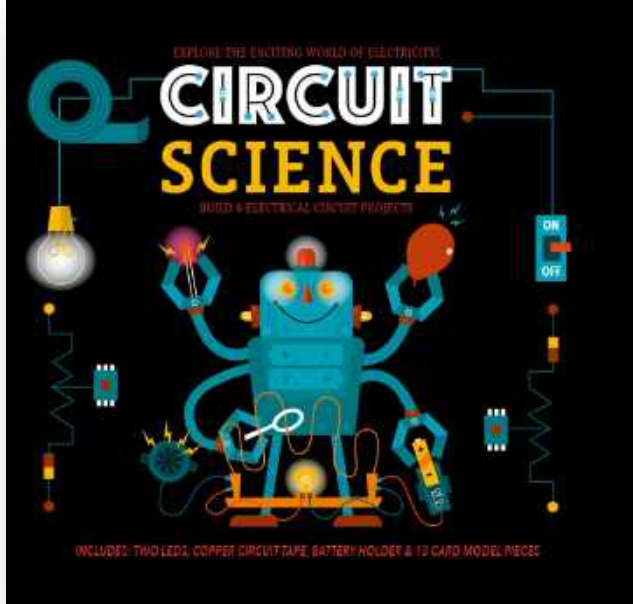

Circuit Science

- The perfect tool for teaching science topics to kids in a hands-on and engaging way.
- Young scientist will learn by doing, as they build and create dynamic circuit projects, absorbing information about scientific principles and physics along the way.
- Build a robot, make a lantern, explore static electricity, and have fun creating circuit games to play, in this entertaining, educational book and box set.



Extent: boxset + 48 pages

TPS (h x w): 230mm x 260mm

Translation files available

RRP: £18.99

Link to presentation/full pages:

[Circuit Science PDF](#)

[Circuit Science AI](#)

BUILD A ROBOT

Robots are the ultimate electrical machines. Some electronic engineers spend years designing and building different robots. In this awesome activity you can try it yourself and create a robot that actually lights up. You're sure to take it home to this deal!

What you need:
Card pieces 5, 6, 7, 8, 9, and 10 (see sheet)
Copper tape
Two LEDs
100µV pack (see sheet)
100µV pack (see sheet)

- 1 Carefully cut strips of copper tape to fit the grey box and one piece 1, 2, three per card piece in place. Make sure it fits over the gaps in the circuit.
- 2 Push the LEDs through the top holes in card piece 20, on either robot.
- 3 Slide card pieces 6 and 7 into the bottom of card piece 5 (the robot's body). Then slide card pieces 8 and 9 (the legs) into the bottom of the top.
- 4 Take your conductive circuit board piece 10, and slot the LEDs through the eye holes in the robot. Use sticky tape to secure it in place.

REMEMBER!
LEDs have a positive (+) side and a negative (-) side. The longer leg on an LED is positive and the shorter leg is negative. Make sure the positive side of the battery is wired to the positive side of an LED.

A LITTLE LIGHT RELIEF

Every evening, billions of people around the world switch on light bulbs. Light bulbs turn electricity into light (and heat). We take them for granted, but 200 years ago light bulbs didn't exist. So how did people live without them?

IF IN THE DARK
Before the Victorian times, people used candles or oil lamps to light their homes. It was hard to see much other than on these light sources, and it was very messy.

INCREDIBLE EDISON
Thomas Edison (1847-1931) was a US inventor and businessman. He was the first person to create a working light bulb, but he was not the first person to develop a complete light and electrical system with wires and power stations. That was the job of Nikola Tesla, who developed more than 3,000 inventions - now taking a type of electric car.

DO YOU KNOW?
Edison tested thousands of materials for light bulb filaments, including human hair. He also discovered that a thin filament of carbonized paper worked better than a thicker one.

TRY IT YOURSELF
If you have a light bulb, you can try to make one. You can use a small piece of wire to make a filament. The filament is the part that glows when you turn on the light. You can also try to make a light bulb that uses a different material for the filament.

TIMELINE

- 1800: James Watt's steam engine improves the efficiency of steam.
- 1800: Alessandro Volta invents the first battery.
- 1800: Thomas Edison invents the incandescent light bulb.
- 1800: Nikola Tesla invents the AC power system.
- 1800: Thomas Edison invents the first practical incandescent light bulb.
- 1800: Nikola Tesla invents the AC power system.
- 1800: Thomas Edison invents the first practical incandescent light bulb.
- 1800: Nikola Tesla invents the AC power system.

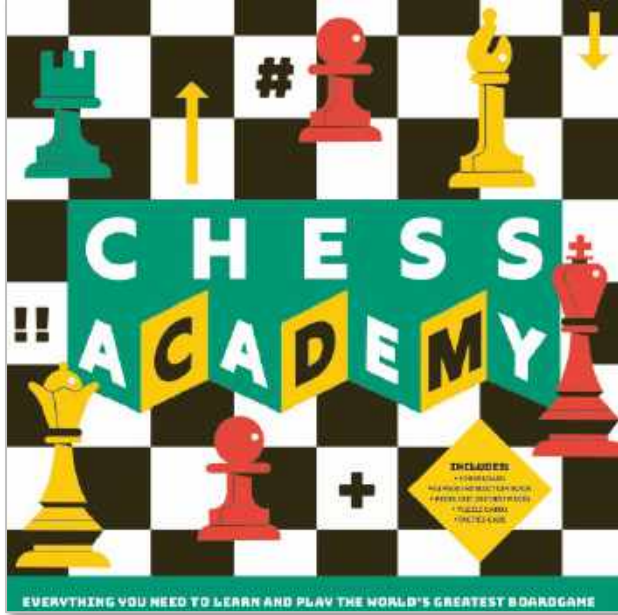

Chess Academy

Written by Levi Rozman aka Gotham Chess

- An interactive, accessible guide to the world's most popular board game
- Written by a world authority on teaching chess to kids, it makes first steps in the game fun, simple and easy to learn
- Fold-away board and press-out pieces allow the reader to practise and compete anytime, anywhere
- Deck of flashcards includes puzzles and drills, so you can hone your skills even if there's no space to lay out a board
- Takes an engaging, modern view of the topic: chess teaching has undergone a revolution in the last 5 years, with an emphasis on fun and drama, instead of dry tactics and learning sequences of moves by rote
- Levy Rozman, aka Gotham Chess, is a New York-based chess writer, teacher and YouTube star, with over 8 million subscribers.

Extent: 64pp

TPS (h x w): 240 x 240mm

Translation files available: TBC

RRP: £24.99

Next co-edition schedule

File to printer: 15 March 2025

Delivery FOB HK: 15 July 2025

Links to presentation/full pages:



The Arty Box: Animals and Dinosaurs

Written by Eleanor Mann and illustrated by Libby Burns

- Gorgeous box sets packed full of art materials, plus a book filled with facts and step-by-step guides
- Packed with 40 sheets of crafting projects, plus simple step-by-step guides for how to use them
- Create amazing animal pictures, models and more • Hours of learning fun for kids aged 3–5, who love creating and crafting
- Fascinating facts add a learning element
- **Featuring:** 4 sticker sheets • 9 card press-out sheets • 3 card stencils • 14 sheets patterned paper • 3 sheets tissue paper • 7 press-out model sheets

Extent: Kit + 32pp book

TPS (h x w): 230 x 165mm

Translation files available:

Animals – June 2024

Dinosaurs – TBC

RRP: £15.99

Link to presentation/full pages:

[The Arty Box – Animals](#)

[The Arty Box - Dinosaurs](#)

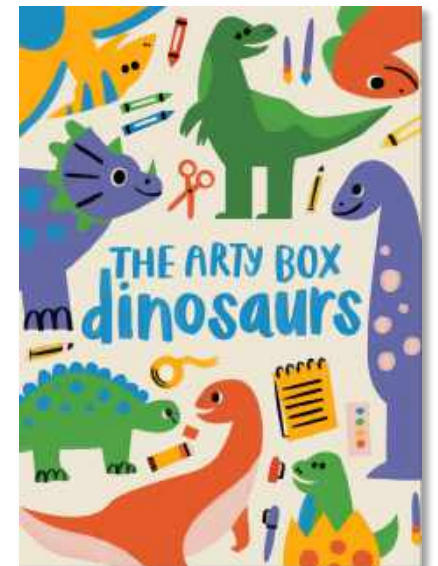
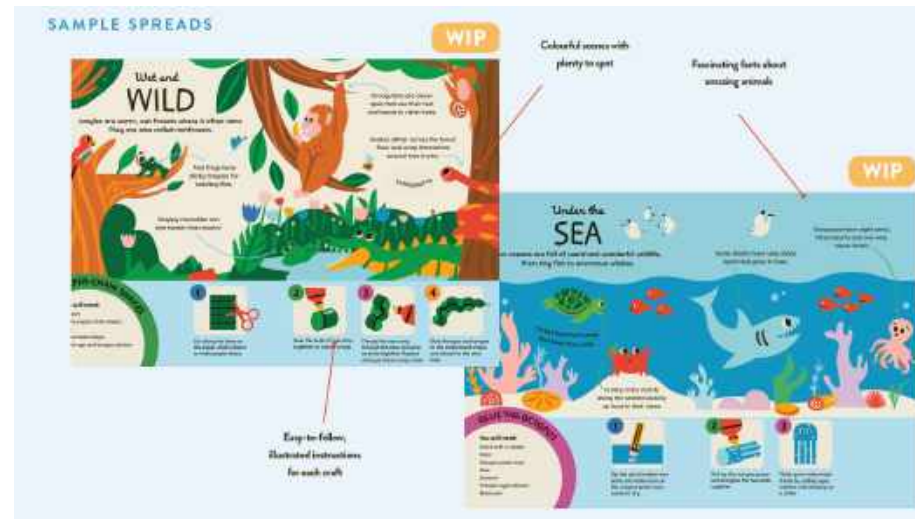

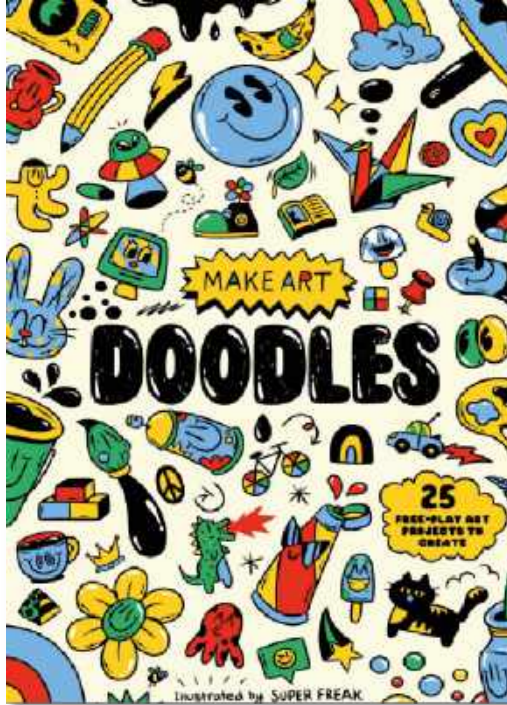

Make Art: Doodle

Written by Shaheen Bilgrami and illustrated by Super Freak

- A doodle book with a difference - includes sections about the history of doodles and freehand doodle interpretation
- Create over 20 unique doodle-themed creative projects - free-play, unique paper toys, stationery and decorations
- Includes step-by-step guides from a leading doodle artist!
- Promotes artistic freedom to aid the development of creative young minds.

Extent: Kit + 48pp book

TPS (h x w): 230 x 165mm

Translation files available: [TBC](#)

RRP: £15.99

Link to presentation/full pages:

[Make Art Doodle \(box format\)](#)

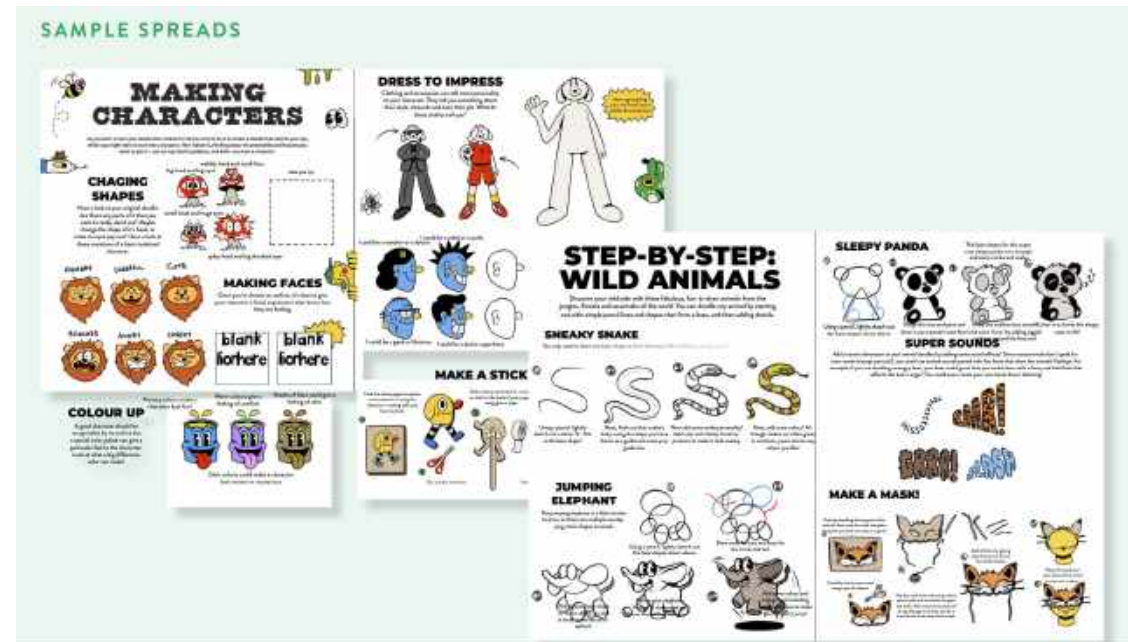



Make Art: Kawaii

Written by Ilaria Ranauro and illustrated by Ellen Philpot

- A Kawaii craft book with a difference - includes sections on the history of Kawaii art and Kawaii fashion and style.
- Includes step-by-step guides from a leading Kawaii artist
- Create over 20 unique Kawaii-themed drawings, free-play toys, stationery and decorations
- Promotes artistic freedom to aid the development of creative young minds

Extent: Kit + 48pp book

TPS (h x w): 230 x 165mm

Translation files available: TBC

RRP: £15.99

Link to presentation/full pages:

[Make Art Kawaii](#)

[Make Art Kawaii - bookplan](#)

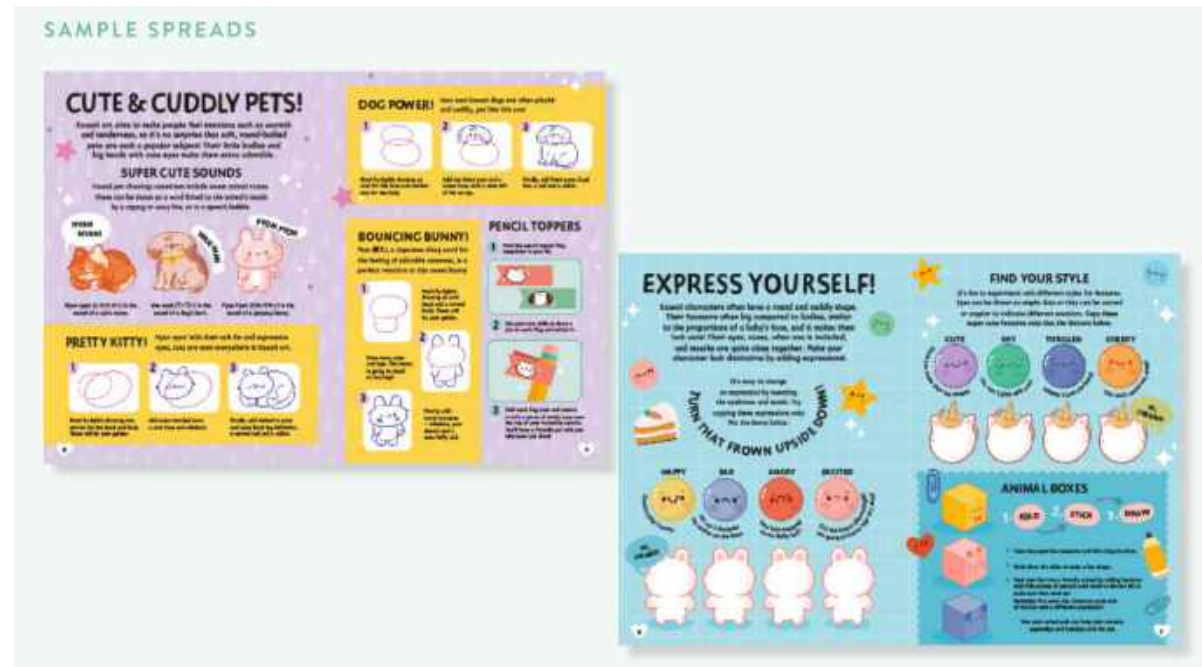



Make Art

- Everything you need to make 25 unique and creative art projects, focusing on imaginative freedom and mindful creativity.
- Create free-play, unique sculptures, collages, paintings and installations. Kit includes (colour): 3 sheets of card stencils, 9 sheets of press-out paper pieces, 3 sheets of coloured tissue paper, 4 sticker sheets, 14 sheets of patterned printed paper, 7 model sheets.
- Learn about 21 key art movements in history with informative text from a leading art author, Susie Hodge. Illustrations by Jenny Bowers.

Extent: Kit + 48pp book

TPS (h x w): 250mm x 180mm

Translation files available: May 2023

RRP: £15.99

Link to presentation/full pages:

Make Art: [PDF](#) – [contents list](#) – [video](#)

[Make Art Kawaii](#)

[Series A1](#)

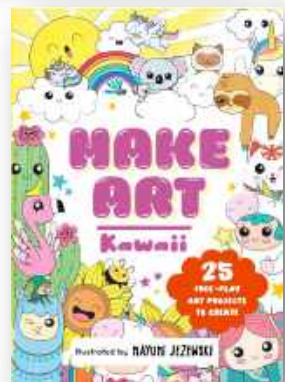

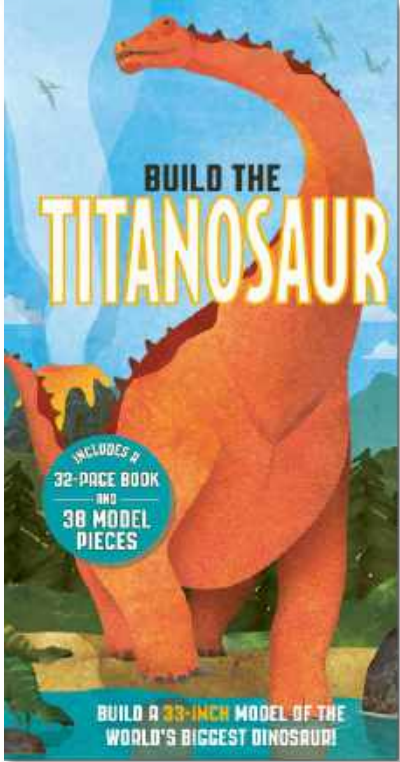

Build The Titanosaur

- Build a 30-cm tall interactive model.
- 32-page book introduces the Titanosaur family, the largest land animals ever to have existed.
- Learn all about these amazing creatures –how they reached such astonishing size, what they ate and the threats they faced in the prehistoric world.

Extent: boxset + 32 pages

TPS (h x w): 360mm x 165mm

Translation files available: April 2024

RRP: £15.99

Link to presentation/full pages:

[Build a Titanosaur](#)

[Photos of Model](#)

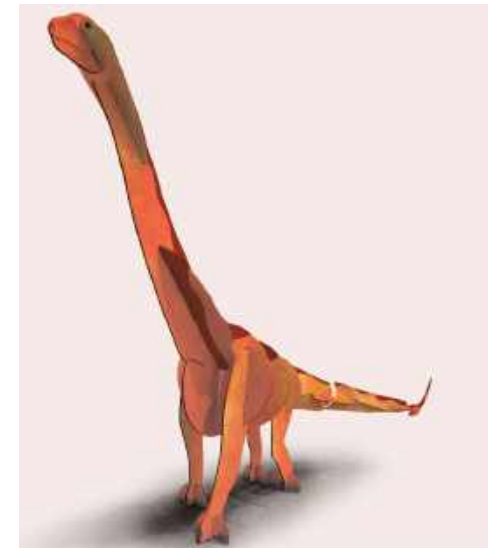

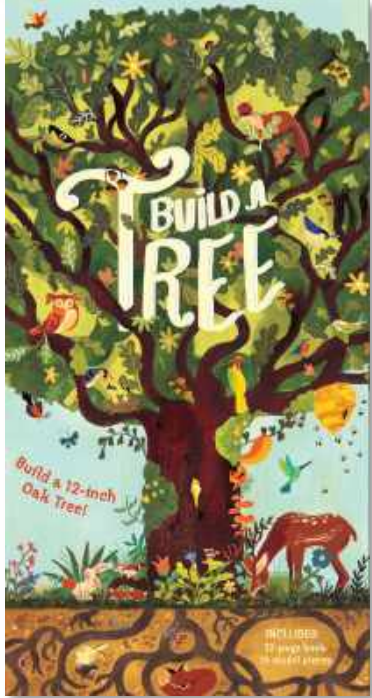

Build a Tree

Written by Philippa Forrester and Illustrated by Natalia Rojas Castro

- Build a 30-cm tall interactive model.
- Create your own oak-tree ecosystem, packed with plants and animals, inside and out.
- 32-page book explores the fascinating world of trees, from profiles of the world's forests, to the animals they support, tree biology, conservation and the incredible fungal networks that lets trees communicate.

Extent: boxset + 32 pages

TPS (h x w): 360mm x 165mm

Translation files available: 15 June 2024

RRP: £15.99

Link to presentation/full pages:

[Build A Tree](#)

[WIP model](#)



3.5 MILLION COPIES SOLD IN THE WORLD!

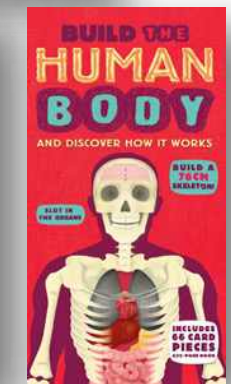



Bowling Alley Science

Written by Nancy Dickmann and illustrated by Donough O'Malley

- A hands-on opportunity for children to build their very own bowling alley and then learn about basic science from its workings, demonstrating real-life applications of key science topics (e.g. exploring how energy is transferred from one object to another).
- A cool handbook, packed with engaging graphics, to help young scientists get to grips with fundamental concepts such as energy, force and acceleration.
- Includes all the components to build your own playable bowling alley.

Extent: boxset + 32 pages
TPS (h x w): 353mm x 222mm
Translation files available
RRP: £18.99

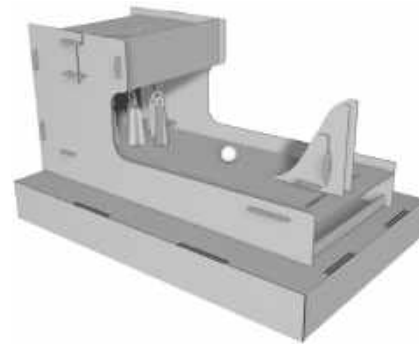

Link to presentation/full pages:

Bowling Alley Science: [PDF](#) – [video](#)
[Pinball Science](#)
[Series A!](#)

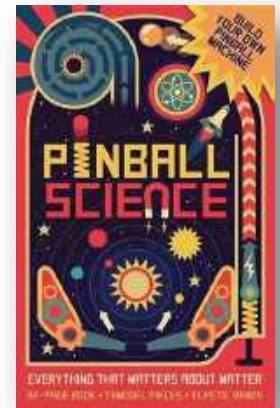

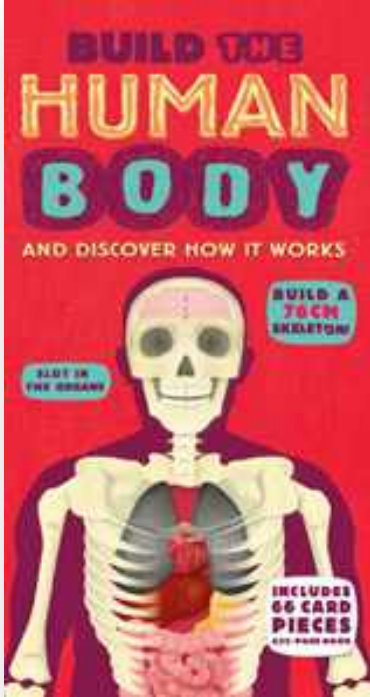

Build A... series

- Learn all about rescue vehicles, space, the human body, insects and many other key subjects thanks to these unique interactive guides.
- Build amazing detailed models from press-out slot-together pieces.
- Bright, bold artwork and clear, informative text.

3.5 MILLION COPIES SOLD IN THE WORLD!

Extent: boxset + 32 pages
 TPS (h x w): 360mm x 165mm
 Translation files available
 RRP: £15.99

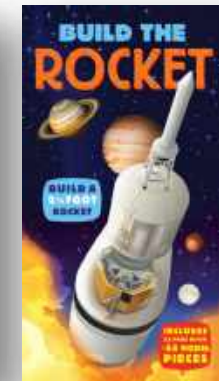
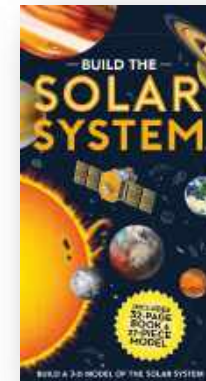

Link to presentation/full pages:

[Solar System](#) · [Rocket](#) · [Robot](#) · [Shark](#) · [Scorpion](#) · [Human Body](#)



Build a Mermaid

- Learn all about mermaids and the lives they lead in this beautiful guide to these fascinating creatures, and also includes some real-life facts about sea life and sea creatures.
- This guide takes a non-fiction and STEM approach to the fictional subject of mermaids, resulting in a beautiful book to be cherished.
- The book also includes 8 model sheets and 21 model pieces to build your own 30cm tall mermaid with a hinged tail.

Extent: boxset + 32 pages

TPS (h x w): 360mm x 165mm

Translation files available: March 2023

RRP: £15.99

Link to presentation/ full pages:

[Build a Mermaid](#)

[Build the Unicorn](#)

[Build the Dragon](#)





Build a Princess

Written by Fiona Munro and illustrated by Vanessa Port

- Perfectly timed for release of Disney’s live action Snow White, the latest Build A title is an on-trend extension to this successful series!
- The 32-page book is an empowering fantasy overview of the life of a dream princess.
- Build a 30-cm tall interactive model, with an array of different outfits, from sports gear to ballgowns, pyjamas to suits of armour!

Extent: boxset + 32 pages

TPS (h x w): 360mm x 165mm

Translation files available: TBC

RRP: £15.99

Next co-edition schedule

File to printer: 15 March 2025

Delivery FOB HK: 15 July 2025

Link to presentation/full pages:

[Build the Princess](#)





Making History series

- Beautiful artwork brings these historic events to life, and readers can also build their own large-scale model!
- Construct your very own models with easy-to-follow instructions and learn everything there is to find out about those incredible constructions and machines through riveting guides.
- Beautifully illustrated by Rui Ricardo.

Extent: boxset + 64 pages

TPS (h x w): 350mm x 480mm

Translation files available

RRP: £21.99



Link to presentation/full pages:

[Titanic](#)

[Mars Rover](#)

[Golden Gate Bridge](#)



Build and Discover series

- Combines 3 build-it-yourself motorised models with a fact-filled 64-page book, providing a complete guide to the fascinating worlds of creepy-crawlies, dinosaurs and animals.
- As you read about how these animals move, hunt and feed, references to detailed cutaway illustrations on the models' body parts add to your understanding.
- Tuck box includes cardstock and wind-up motors to make 3 mechanical models.



Extent: boxset + 64 pages
TPS (h x w): 240mm x 140mm
Translation files available
RRP: £19.99

Link to presentation/full pages:

[Insects](#)

[Dinosaurs](#)

[Animals](#)

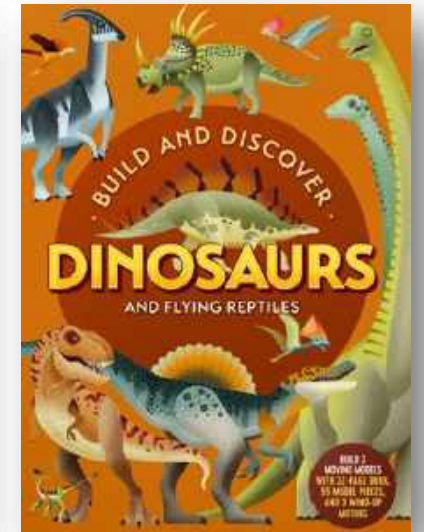
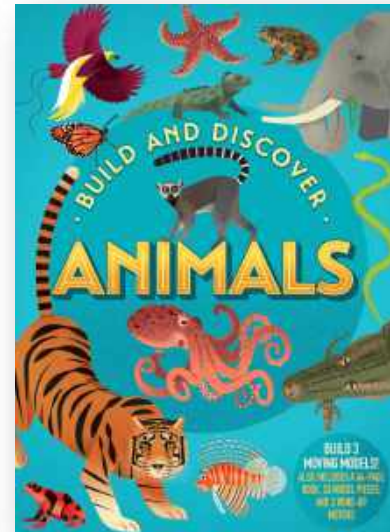

Your World Through... A Microscope / A Telescope

- Get a different perspective on your life with this fascinating STEAM book and build-your-own x30 microscope or telescope.
- Using easy-to-find objects as a starting point for discussion of science and technology, the book takes a close-up look at environments every child will be familiar with, in the home, the garden or in the sky.
- As well as including information on how to create slides and get the most out of their microscope, topics such as yucky body bits and bug hunt will attract young readers!

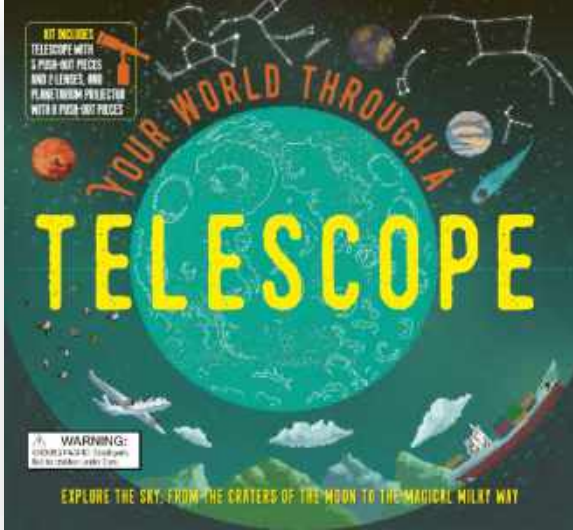

Extent: boxset + 48 pages

TPS (h x w): 240mm x 267mm

Translation files available

RRP: £21.99



Link to presentation/full pages:

[Your World Through a Microscope](#)

[Your World Through a Telescope](#)

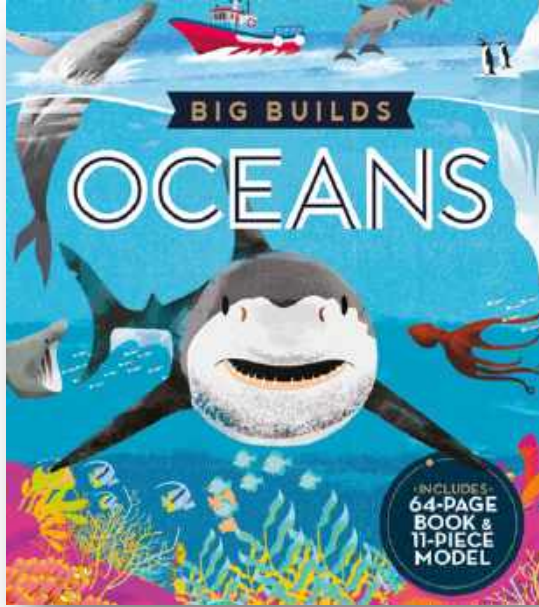

Big Builds series

- These fun and fact-packed books will inspire budding geographers, biologists, astronomers and zoologists, and each has its own model to build, explore and display.
- In OCEANS readers will take a journey from the base elements at the bottom of the ocean to the layers at the very top, taking in the fascinating wildlife it supports along the way.
- PLANET EARTH explores the different layers of Earth's geography, along with the animals and humans that it supports.
- SOLAR SYSTEM travels from the heat of the sun to distant Neptune, looking at all the planets along the way.

Extent: boxset + 64 pages

TPS (h x w): 260mm x 230mm

Translation files available

RRP: £19.99

Link to presentation/full pages:

[Big Builds Ocean](#)

[Big Builds Planet Earth](#)

[Big Builds Solar System](#)

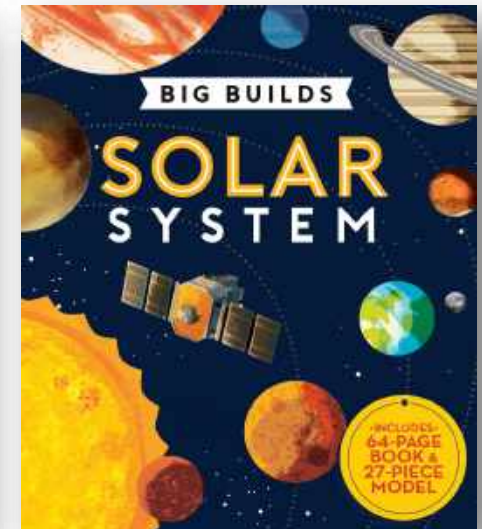
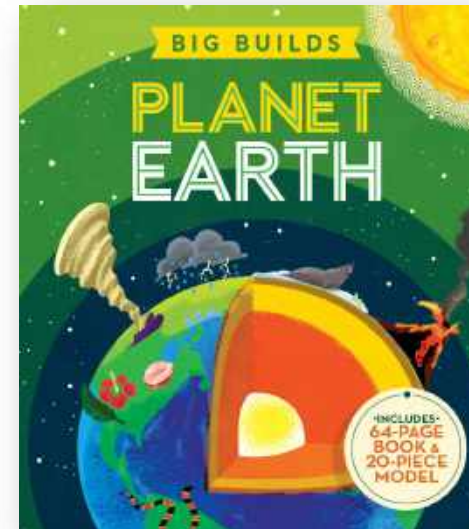



Busy Builds: Princess Castle

- Peek into the life of princesses with this beautiful folding-out play set. Fanciful die-cut model princesses sit about a multi-level, three-dimensional enchanted castle.
- Includes an illustrated princess handbook and a pocket full of projects to punch out and assemble.
- Build your own slot-together model princess characters and miniature objects with 32 press-out card model pieces.

Extent: boxset + 32 pages

TPS (h x w): 250mm x 180mm

Translation files available: October 2023

RRP: £24.99

Link to presentation/full pages:

Princess Castle: [PDF](#) - [model rough](#)

[Series A1](#)





Busy Builds: Unicorn Palace

- A doll's house in a box: the perfect combination of reading and playtime
- Unicorns are an ever-popular fantasy theme with high sales across all markets
- Easy to build, easy to tidy away, this sturdy kit is designed to become a treasured keepsake
- Sturdy box folds out into a gorgeous 3D play scene, with six rooms, gardens, and 30 press-out characters perfect for imaginative play!

Extent: boxset + 32 pages

TPS (h x w): 250mm x 180mm

Translation files available: TBC

RRP: £24.99

Next co-edition schedule

File to printer: 15 March 2025

Delivery FOB HK: 15 July 2025

Link to presentation/full pages:

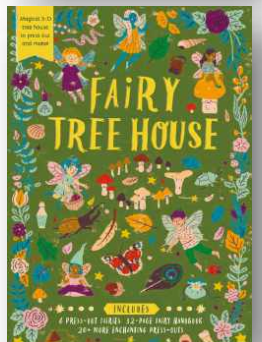
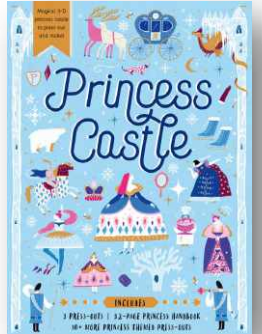



Busy Builds: Santa's Workshop

- The detailed festive handbook tells you all you need to know about Santa and his busy workshop. The box folds out into a pop-out model of Santa's Workshop, and includes lots of miniature models to play with.
- Highly decorative and detailed artwork by Harriet Seed.
- A stunning keepsake to enjoy every year.

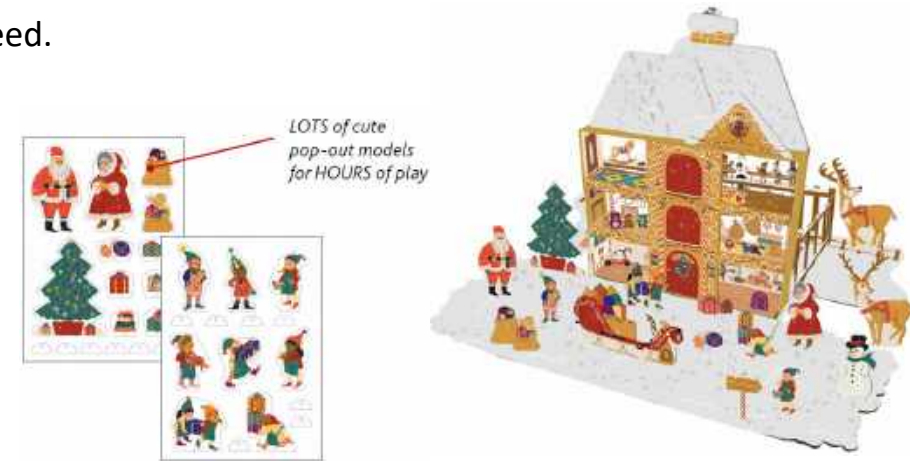

Extent: boxset + 32 pages

TPS (h x w): 250mm x 180mm

Translation files available: April 2023

RRP: £24.99

Link to presentation/full pages:

Santa's Workshop: [PDF](#) – [video](#) – [model rough](#)

[Series A1](#)





Busy Builds: Fairy Tree House

- Peek into the secret world of fairies with this beautiful folding-out play set. Fanciful die-cut model fairies flit about a multi-level, three-dimensional enchanted tree house.
- Includes an illustrated fairy handbook and a pocket full of projects to punch out and assemble: make a fairy carousel, dress a fairy, and create a flapping dragonfly mobile.
- Build your own slot-together model fairy characters and miniature objects with 32 press-out card model pieces.



Extent: boxset + 32 pages
TPS (h x w): 250mm x 180mm
Translation files available
RRP: £24.99

Link to presentation/full pages:

Fairy Tree House: [PDF](#) - [video](#)

[Series A1](#)





Busy Builder series

Written by Timothy Knapman and illustrated by Carles Ballesteros

- Learn about life on a pirate ship in this fact filled book, that comes with a fun playset and card models, illustrated by acclaimed artist Carles Ballesteros.
- Open the box and turn it into a model of the ship, with jigsaw pieces to create the pirate scene. Build your own slot-together models of the captain, crew and cannons to bring the scene to life.
- All the pieces can be dismantled and replaced in the box, along with the book, for easy storage and repeated play.

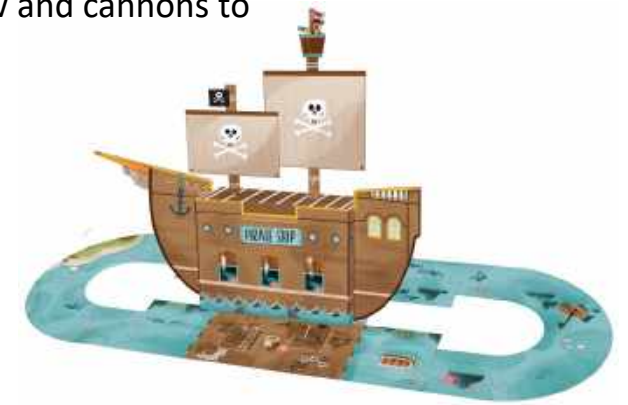

Extent: 32 pages

TPS (h x w): 250mm x 180mm

Translation files available: Now

RRP: £24.99

Links to presentation/full pages:

[Busy Builders: Pirate Ship](#)

[Fire Station](#) · [Airport](#) · [Construction Site](#) · [Farm](#)

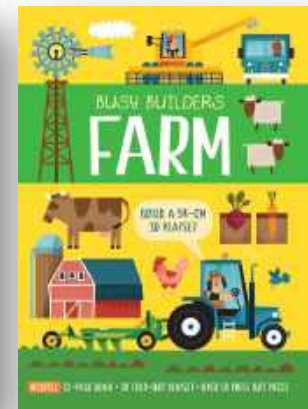
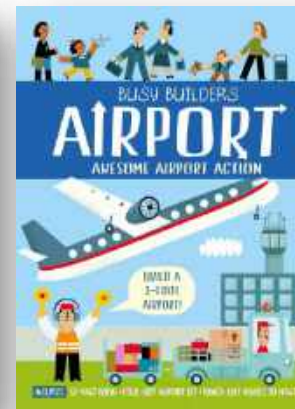

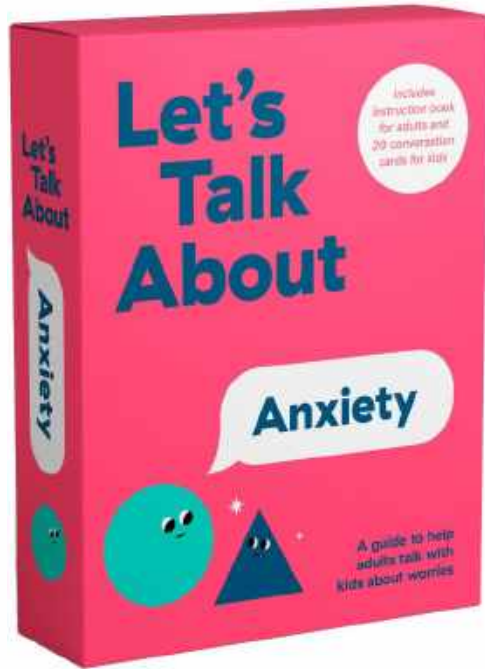

Let's Talk About... Anxiety/ Friendship

written by Sharon Selby; Casey O'Brien Martin & Kim Davies



- A guidebook and conversation cards packaged in a lovely sleeve box to help kids and adults address and discuss difficult topics.
- Practical exercises work in conjunction with the cards to create ice-breaking 'conversation starters' and provide helpful guidelines and tips for discussion.
- On the back of the proven success of 'Cards Against Anxiety' (Adults list), mental health and wellbeing are growing areas of concerns for adults and young children, and an increasing point of emphasis for parents and teachers.

Extent: 64 pages + 20 cards (140 mm x 100 mm)

TPS (h x w): 160mm x 120mm

Translation files available

Link to presentation/full pages:

[Let's Talk About Anxiety](#)

[Let's Talk About Friendship](#)

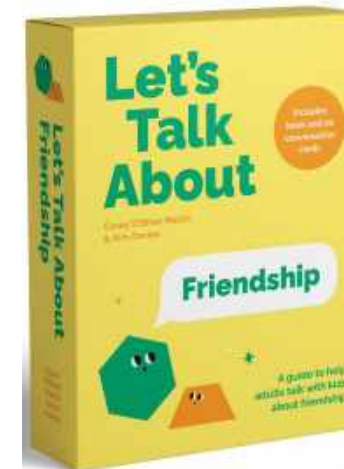
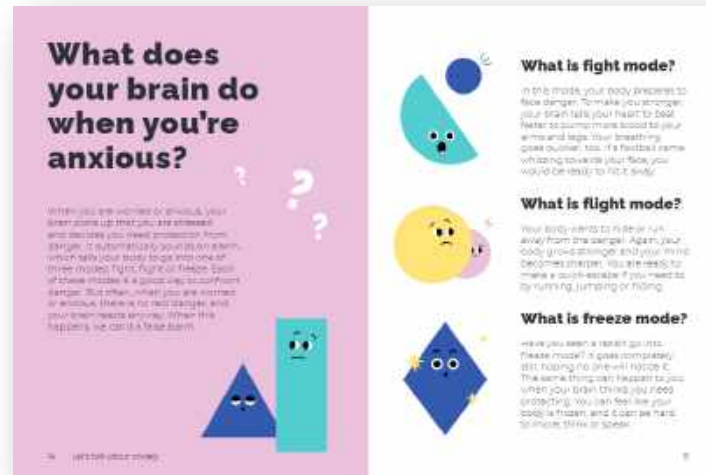

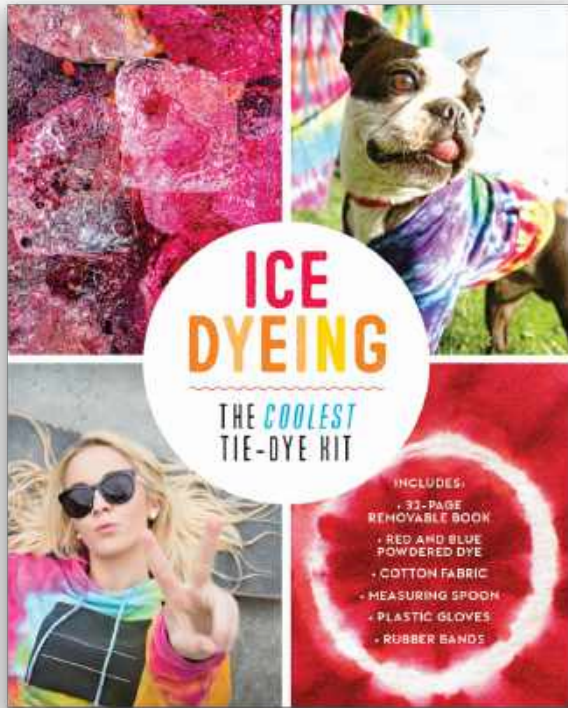

Ice Dyeing: The Coolest Tie-Dye Kit

- The coolest tie-dye kit! With just the supplies included in this kit and a heap of ice, make brightly tie-dyed patterns on clothes, bedding, towels, or any other fabric.
- Prepare a shirt or cloth for a regular tie-dye experience, but instead of using liquid dye, pile ice on top of it. Then, use the included special powder wand to scatter powdered dye evenly. As the ice melts, the fabric takes on the colour, which spreads like a rainbow.
- Learn the science behind colour mixing as you dye anything and everything in unique patterns and shades with the ice-dyeing technique.

Extent: Kit with 32 pages book
TPS (h x w): 247mm x 196mm
Translation files available

Link to presentation/ full pages:
[Ice Dyeing](#)
[Check out even more awesome features through this video link!](#)



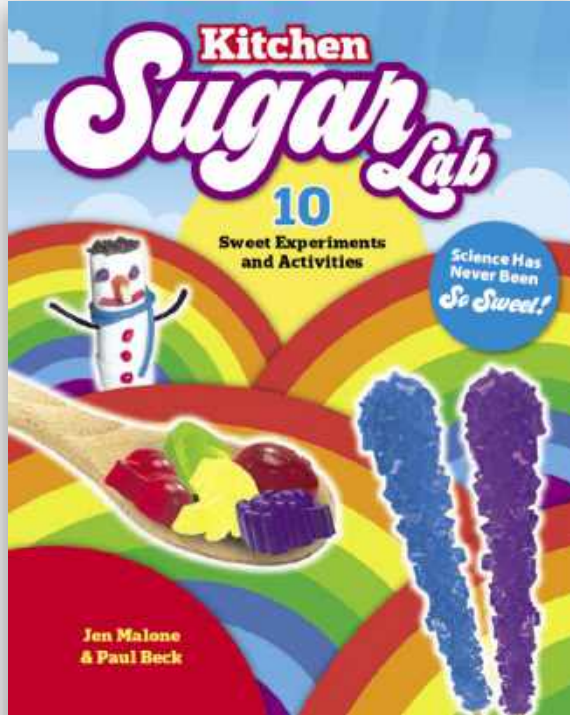

Kitchen Sugar Lab

- Science has never been sweeter! Learn the science of sugar with this activity-packed kit.
- Sugar is the building block for the 10 super sweet activities and experiments. Follow easy, step-by-step instructions to make sweet treats and learn the science behind sugar bubbles, floating eggs, and burping balloons with the included 32-page lab book, sugar balloons, sugar bubble wand, wood rock candy sticks and candy mold.
- Reusable components and endless variations make this a kit you can use over and over again!

Extent: Kit with 32 pages book
 TPS (h x w): 247mm x 196mm
 Translation files available

Link to presentation/ full pages:
[Kitchen Sugar Lab](#)





Treasure Chest Pirates

Written by Nancy Dickmann and illustrated by Aldo Crusher

- Bring the past to life as you immerse yourself in the life and customs of pirates through the Golden Age of Piracy and beyond!
- Stylish contemporary illustrations and four hands-on pirate-themed models to build and play with – a pirate ship, a sword, a treasure chest and a tricorne hat!
- Learn about the lives of famous historical pirates, male and female, from around the world, discover the meanings behind their flags, learn how to talk like a pirate and find out what life was really like aboard a pirate ship, and much more
- Includes fun pirate-themed activities, games, crafts and recipes to create at home using everyday household items and ingredients

Extent: boxset + 48 pages

TPS (h x w): 347mm x 267mm

Translation files available

RRP: £21.99

Link to presentation/full pages:

[Treasure Chest Pirates](#)

[Treasure Chest Middle Ages](#)

[Series A1](#)

[Models + Videos](#)

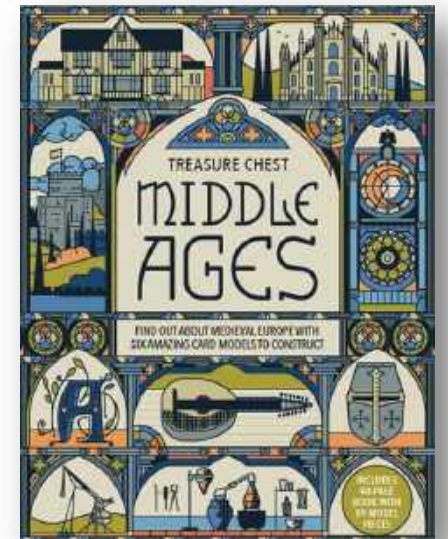
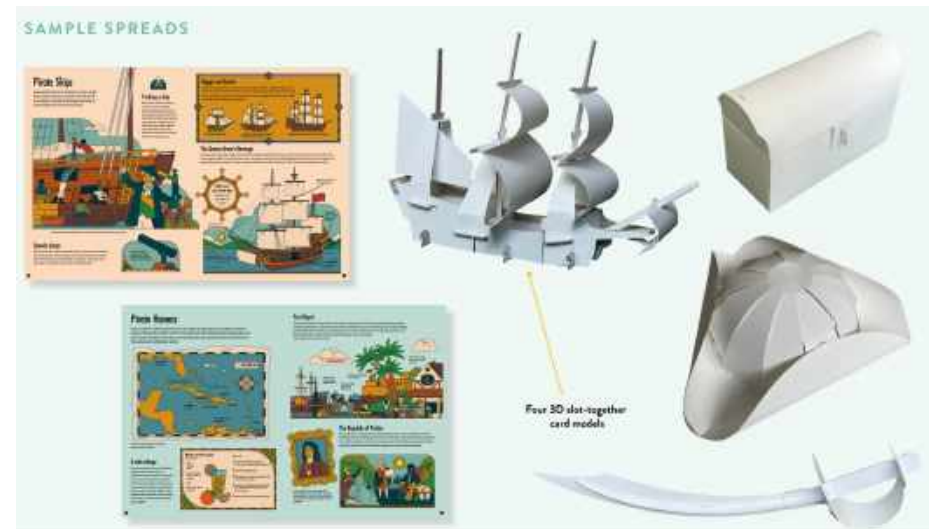

Treasure Chest Ancient Greece

Written by Nancy Dickmann and illustrated by Aldo Crusher

- Bring the past to life as you immerse yourself in the life and customs of the ancient Greeks!
- Stylish contemporary illustrations and four hands-on ancient Greek-themed models to build and play with
- Explore the Greek world, from the ancient Olympics and the infamous Spartans to the birth of democracy, gods and goddesses and famous thinkers and writers
- Discover how the ancient Greeks lived, what they ate, how they dressed and how they entertained themselves. Learn about myths and legends and much more.
- Includes fun activities, games, crafts and recipes to create at home using everyday household items and ingredients

Extent: boxset + 48 pages

TPS (h x w): 347mm x 267mm

Translation files available: TBC

RRP: £21.99

Next co-edition schedule

File to printer: 1 April 2025

Delivery FOB HK: 15 July 2025

Link to presentation/full pages:

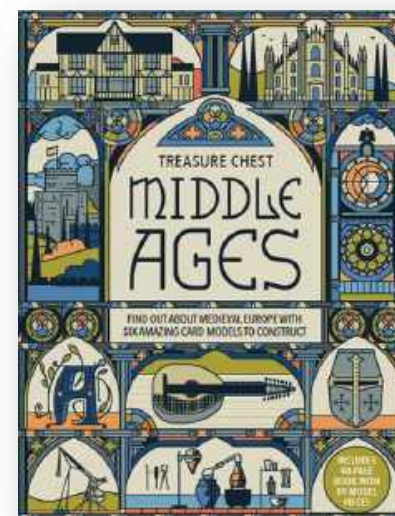
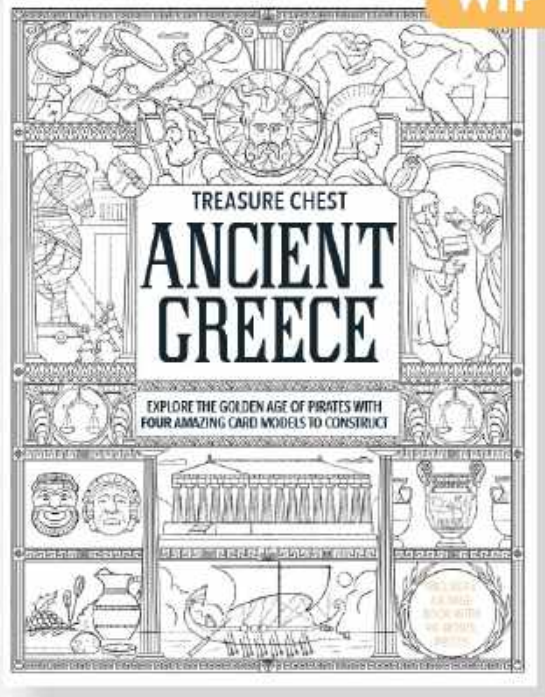

Q.

Novelty Books

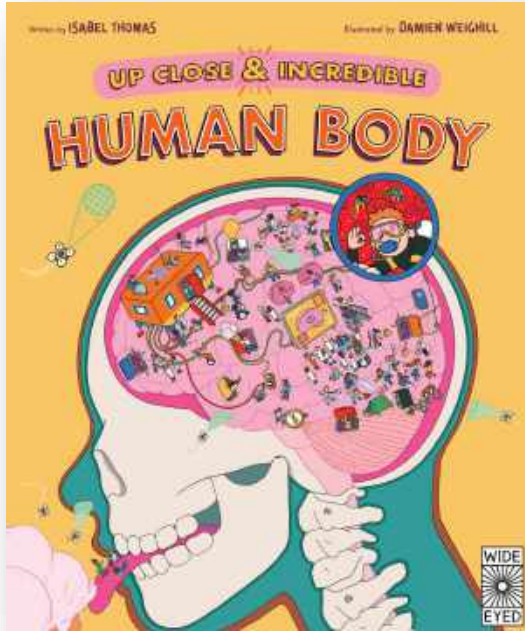

Up Close & Incredible: Human Body

Written by Isabel Thomas and illustrated by Damien Weighill

- New search-and-find adventures await in this magnified trip around the inner workings of the human body, packed with hundreds of funny and fascinating details to spot.
- Explore what goes on inside your organs, bones, muscles and more, using the included 3x magnifying glass to spot hundreds of hidden and hilarious details.
- Written by award-winning author Isabel Thomas, the text takes a no-nonsense, fact-packed look at every major system in the human body.
- But nonsense is provided in spades on each ridiculously detailed spread, thanks to Damien Weighill's trademark sense of humour, which neatly visualises fascinating topics within biology and medicine in cartoon form.

Extent: 48 pages + magnifying glass

TPS (h x w): 310mm x 256mm

Translation files: December 2023

Retail price: £16.99

Link to presentation/full pages:

[Up Close & Incredible: Human Body](#)

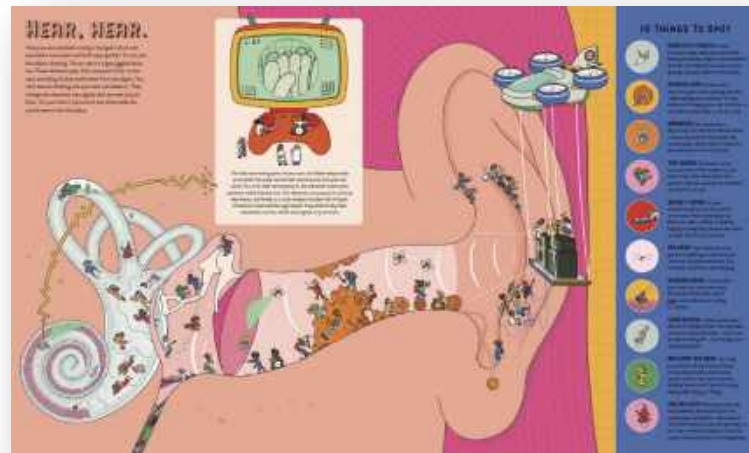



Life Behind Doors: Iconic Monuments

Written by Clive Gifford and Illustrated by Naida Mazzenga

- Discover 13 of the world's iconic buildings like never before: lift flaps and open gatefolds to explore scenes of life as it was at the time of the building's prime
- Combines detailed photographs of the buildings, humorous and instructive illustrations and educational content written in a very accessible style
- Search-and-find prompts encourage the reader to pore over the artwork and notice cultural and historical details

Extent: 32pp

TPS (h x w): 290 x 235mm

Translation files available: [TBC](#)

RRP: £17.99

Link to presentation/full pages:

[Iconic Monuments](#)

[Contents List](#)

[Life Behind Doors: Iconic Monuments - AI](#)



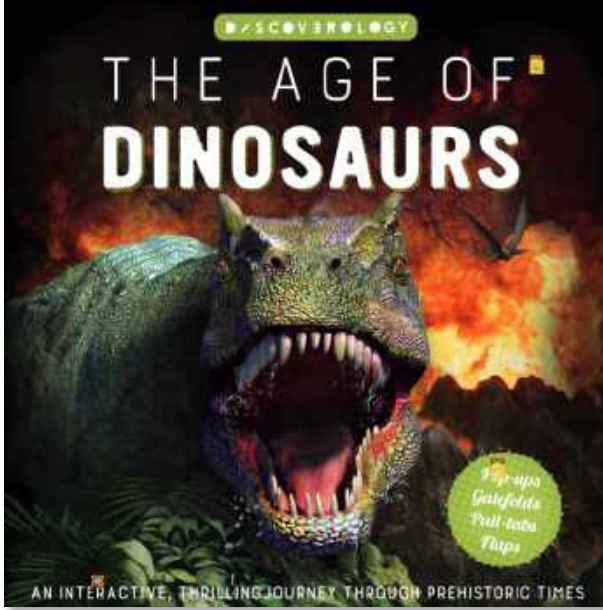

Discoverology: Space and Dinosaurs

Consultants – Dr Jacqueline Mitton / Douglas Dixon

- An interactive series of large format fact-packed books
- Featuring pop-ups, mini-booklets, spinning wheels, fold-out pages and flaps to lift
- Stunning photography

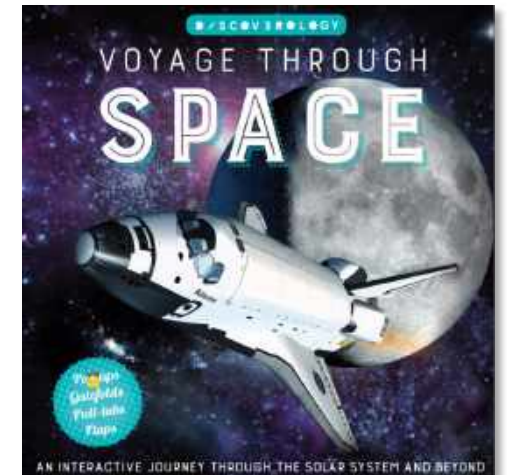

Extent: 30pp

TPS (h x w): 255 x 255mm

Translation files available: TBC

RRP: £19.99

Link to presentation/full pages:

[Discoverology – Dinosaurs](#)

[Discoverology - Voyage Through Space](#)



Sound Explorers

Written by Timothy Knapman and Illustrated by Wesley Robins

- A must-have gift series for budding scientists
- 20 unique space sounds from all over the Universe
- Offers a completely new and interactive way of learning about space
- Includes new space and science discoveries
- Series Extension: *Under Water, Night Time*

Extent: 48pp Hardback + sound panel

TPS (h x w): 266 x 201mm

Translation files available: June 2024

RRP: £19.99

Link to presentation/full pages:

[Sound Explorers Space Adventure - Video](#)

[Sound Explorers Space – PDF](#)

[Sound Explorers Space - Sound Links](#)

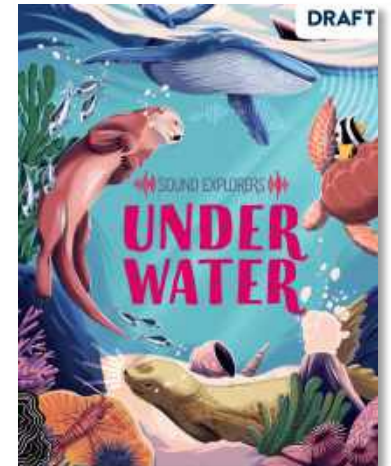



Maze Hero: Myths and Monsters

Written by Marney Willow & Illustrated by Kelly Chong

- Impressive 3D pop-up mazes, fiendish puzzles and highly detailed artwork make this a high value gift. Perfect for fans of table-top role playing games, puzzlers and myths and legend lovers.
- When your mysterious librarian aunt goes missing, your summer visit takes an unexpected turn. Left behind is the Mappa Mythica, a book brimming with enchanted creatures on the brink of breaking free. In her note, she reveals she's ventured into its pages to prevent disaster. But if she doesn't return, it's up to you to embark on an epic quest to rescue her!
- Discover 12 mythical maze worlds based on mythology and legends from around the world, from icy Inuit Arctic worlds and Ancient Egyptian pyramids to underwater monsters and shipwrecks and Polynesian myth worlds.
- Each world combines atmospheric text, beautifully detailed artwork to pore over and a unique 2D or 3D maze, puzzles and codes to crack that will keep readers entertained for hours.

Extent: 24 pages

TPS (h x w): 320mm x 236mm

Translation files available: Now

RRP: £14.99

Next co-edition schedule

File to printer: 1 April 2025

Delivery FOB HK: 15 July 2025

Link to presentation/full pages:

[Magic Magnifying Glass](#)



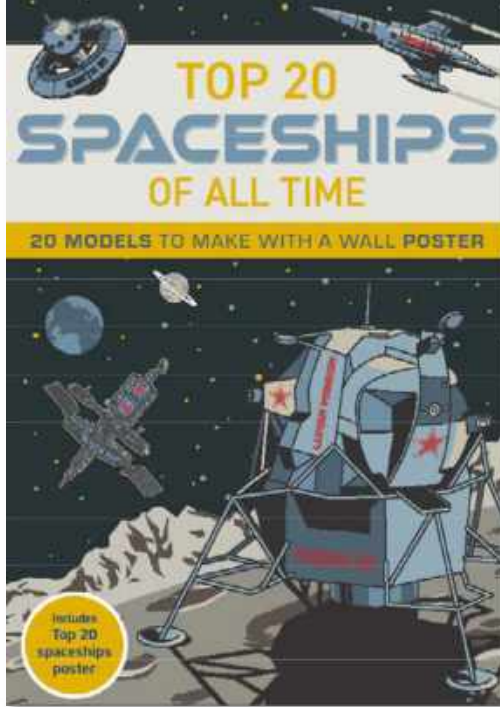

Top 20

- A wonderful new gift series with crossover appeal, for car, space, and movie enthusiasts of all ages.
- Featuring 20 iconic car models / spaceships to build, with press-out, printed card model pieces, each accompanied by a fact file
- Plus a fantastic wall poster
- Perfect family bonding activity
- Two Titles Available:
 - **Top 20 Spaceships of all time**
 - **Top 20 Movie Cars of all time**

Extent: 64pp

TPS (h x w): 297 x 220mm

Translation files available: [TBC](#)

RRP: \$19.99

Next co-edition schedule

File to printer: 1 April 2025

Delivery FOB HK: 15 July 2025

Link to presentation/full pages:

[Top 20 Movie Cars](#)

[Top 20 Spaceships](#)

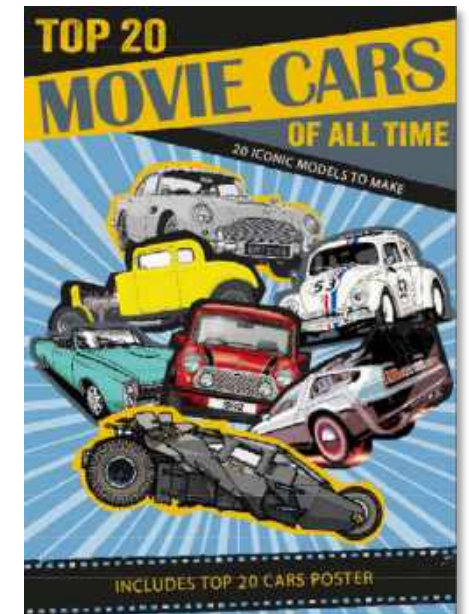
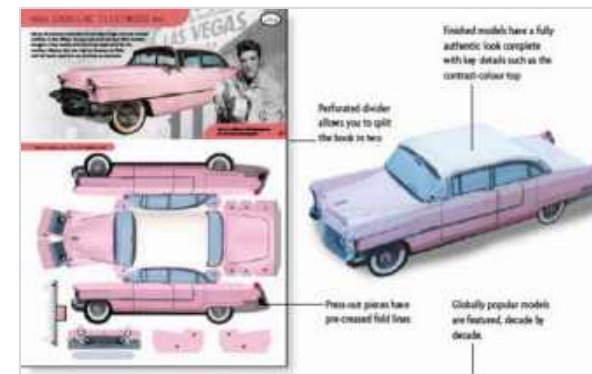



Lift and Find: Super Cute Kawaii Pets

- This beautifully-illustrated, large-scale board book is packed with all things cute and kawaii!
- With 25 flaps to lift per title, young readers will love to learn more as they uncover hidden surprises.
- Stylish, detailed artwork will absorb young readers.

Extent: 12 pages

TPS (h x w): 307mm x 247mm

Translation files available: mid September 2024

RRP: \$15.99

Links to presentation/full pages:

[Lift and Find: Super Cute Kawaii Pets – PDF](#)

[Lift and Find: Super Cute Kawaii Pets - AI](#)



Busy Builds Book: Fairy Treehouse

Illustrated by Mike Love

- A doll's house in a book: perfect combination of story and play
- On-trend topic, timed to pick up on burgeoning interest in fairies
- Easy to fold up and put away, to make a treasured keepsake
- *Series Extension:*
 - Santa's Workshop

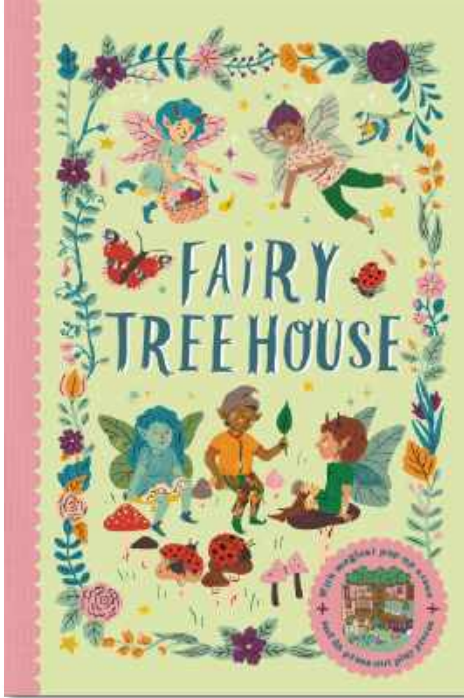

Extent: 32 pages

TPS (h x w): 250 x 180mm

Translation files available: **TBC**

RRP: £15.99

Link to presentation/full pages:

[Busy Builds Book: Fairy Treehouse – PDFs](#)

[Busy Builds Book: Fairy Treehouse – AI](#)



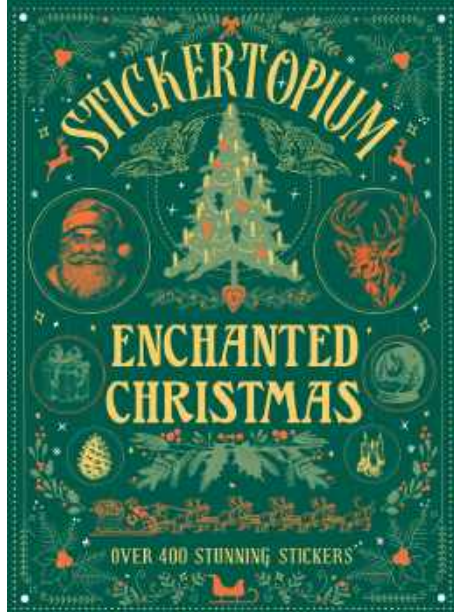

Stickertopium

- Beautiful embellished keepsake sticker books
- Each contains over 400 stunning stickers
- Perfect for decorating, scrapbooking, crafting and collecting
- Crossover title - perfect for crafty teens and adults
- Popular retro art stickers, in a contemporary book



Extent: 96pp

TPS (h x w): 195 x 145mm

Translation files available:

Gothic – 8 April 2024

Christmas – 17 May 2024

RRP: £14.99

Link to presentation/full pages:

[Stickertopium - Gorgeous Gothic](#)

[Stickertopium - Enchanted Christmas](#)

[Stickertopium - Once Upon a Time](#)

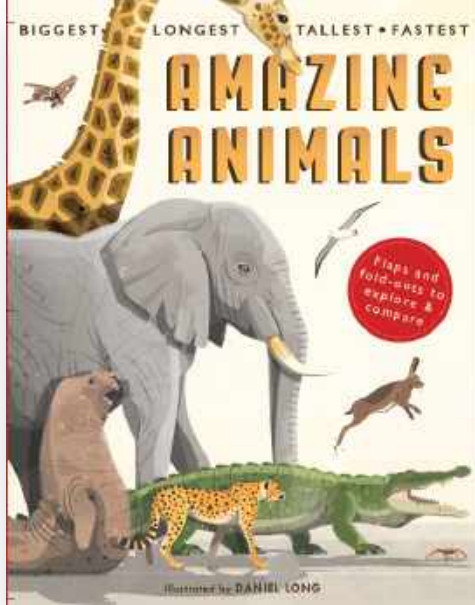

Biggest Longest Tallest Fastest

- Some books give you big. Others give you bigger. This one gives you biggest! With innovative double gatefolds that unfold twice, both vertically and horizontally, nature's giants are literally bursting out of the page.
- Gatefolds are accompanied by a wealth of flaps to open and explore.
- Combined with beautiful animal illustrations and informative text, it adds up to a comparisons book that goes further than the rest.

Extent: 64 pages

TPS (h x w): 307mm x 247mm

Translation files available

RRP: £19.99

Link to presentation/full pages:

[Amazing Animals](#)

[Incredible Oceans](#)

[World of Dinosaurs](#)

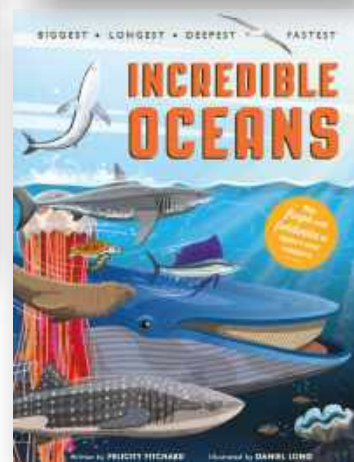
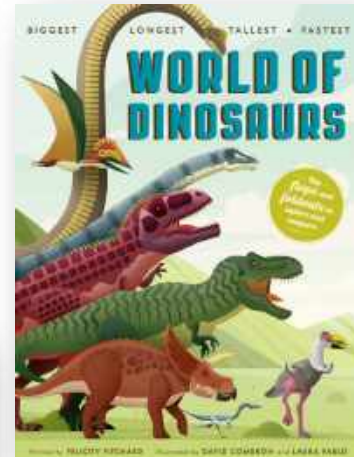
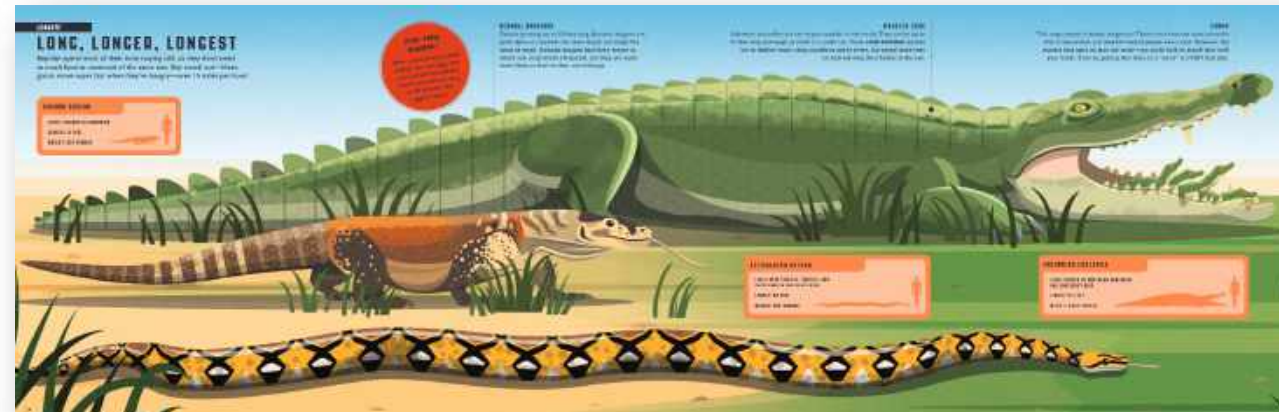

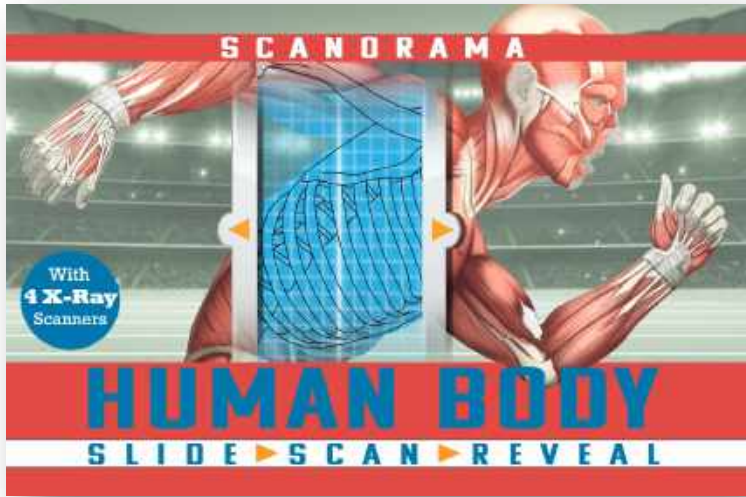

Scanorama series

Written by Anna Claybourne

- Four interactive X-ray slider mechanisms let you see inside the human body, and discover tremendous animals, as if by magic!
- Packed with facts, diagrams, in a bite-size format

Extent: 32 pages

TPS (h x w): 215mm x 330mm

Translation files available

RRP: £19.99

Link to presentation/full pages:

[Scanorama: Amazing Animals](#)

[Scanorama: Deadly Predators](#)

[Scanorama: Dinosaurs](#)

[Scanorama: Human Body](#)

[Series A1](#)

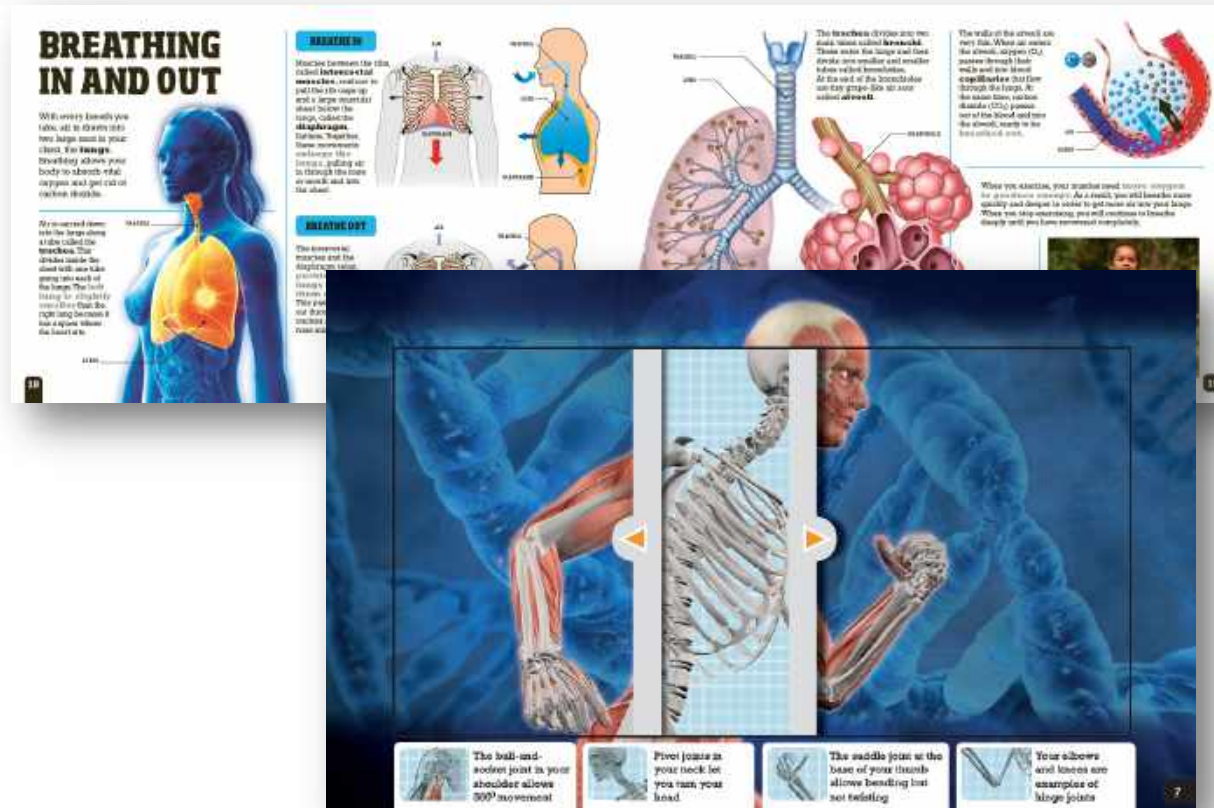

WIP



Quarto

Sound Explorers

Written by Timothy Knapman and Illustrated by Wesley Robins

- A must-have gift series for budding scientists
- 25 unique space sounds from all over the Universe
- Offers a completely new and interactive way of learning about space
- Includes new space and science discoveries
- *Series Extension: Under the Sea / Nighttime*

Extent: 64pp Hardback + sound panel

TPS (h x w): 266 x 201mm

Translation files available: TBC

RRP: £19.99

Link to presentation/full pages:

[Sound Explorers Space Adventure - Video](#)

[Sound Explorers: Space](#)

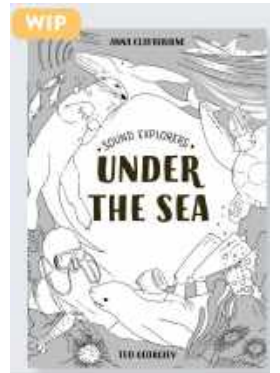

SAMPLE SPREADS





Incredible Journeys

Written by Angela Sangma Francis and Illustrated by Vuon Studio

- A unique book format, expertly crafted for an immersive learning experience.
- The character play piece interacts with each page and the lyrical non-fiction text full of easy-to-comprehend facts, narrates the amazing animal life cycle.
- Stunning naturalistic illustrations by Vuon Studio create a sense of wonder and awe.
- Series Extension: *Burn Bright, Little Star*



Extent: 16pp

TPS (h x w): 240 x 220mm

Translation files available: June 2024

RRP: £10.99

Link to presentation/full pages:

[Incredible Journeys: Little Turtle Little Turtle's Big Ocean Journey - Video New Dummy](#)

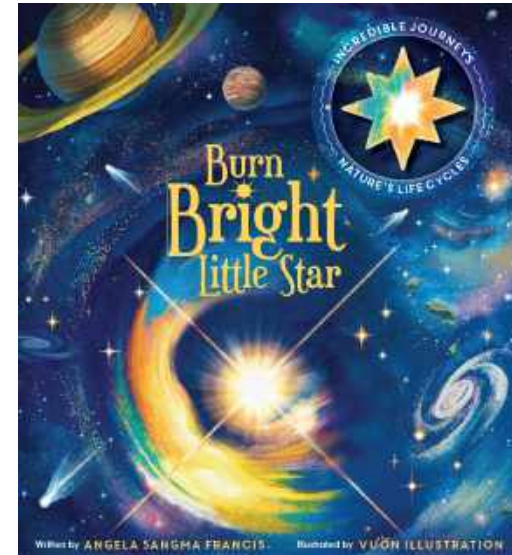



Christmas is Coming – Advent Calendar

Illustrated by Maria Nerdadova

- This beautifully-illustrated gift set contains a library of 24 storybooks, one for each day of Advent
- Each book introduces a different activity in Santa's workshop, from sorting letters to Santa to delivering presents on Christmas Eve
- Builds to a big Christmas surprise – once all the books have been taken out, flip them over to reveal a festive picture puzzle
- Charming, vintage-inspired illustration, sure to evoke Christmas nostalgia

Extent: 24 mini board books in Advent box
TPS (h x w): 250 x 175mm / 25.4 x 25.4mm
Translation files available: TBC
RRP: \$34.99

Next co-edition schedule

File to printer: 01 April 2025

Delivery FOB HK: 15 July 2025

Link to presentation/full pages:



Joy To The Whole World

Illustrated by Sang Miao

- Discover the unique ways children across the world celebrate Christmas in this captivating festive guide with 144 flaps to open.
- This fact-packed around-the-world adventure is designed to be revisited year after year in the lead-up to Christmas, reminding readers all about the value of other cultures and the importance of accepting differences.
- Each striking two-page spread covers the traditional Christmas foods, decorations and symbols of 10 different countries, complete with warm and merry illustrations to get readers ready for this wonderful celebration of love, harmony and goodwill to all.

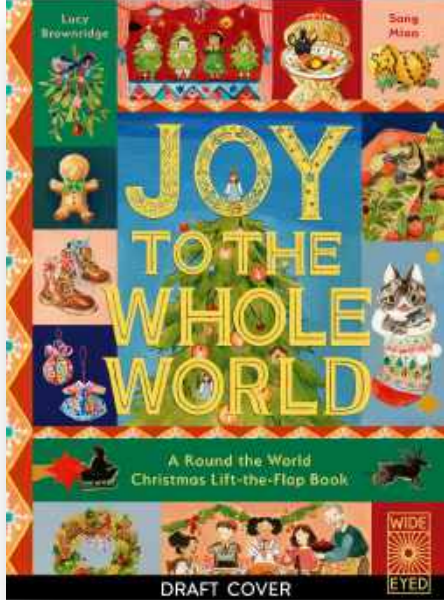

Extent: 24 pages + 144 mini-flaps

TPS (h x w): 278mm x 200mm

Translation files: May 2024

Retail price: £14.99

Next co-edition schedule

File to printer: 15 May 2024

Delivery FOB: 01 September 2024

Link to presentation/full pages:

[Joy To The Whole World](#)



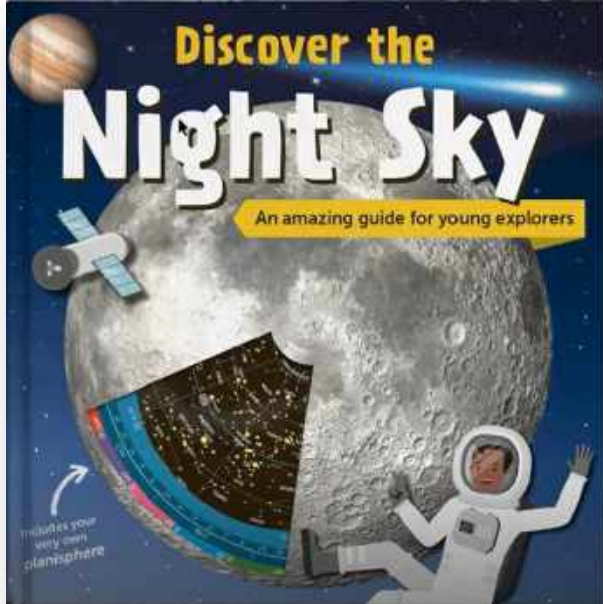

Discover the Night Sky



Quarto

- Launch yourself on a learning adventure and explore the world and beyond! The extraordinary images and illustrations of this title will bring the subject to life.
- This book is filled with amazing facts that help children to digest the complexity of the space with awe and wonder.
- Includes a moving planisphere that can be used in conjunction with the book, with a practical guide on how to use it.

Extent: 64 pages + planisphere
TPS (h x w): 230mm x 230mm
Translation files available

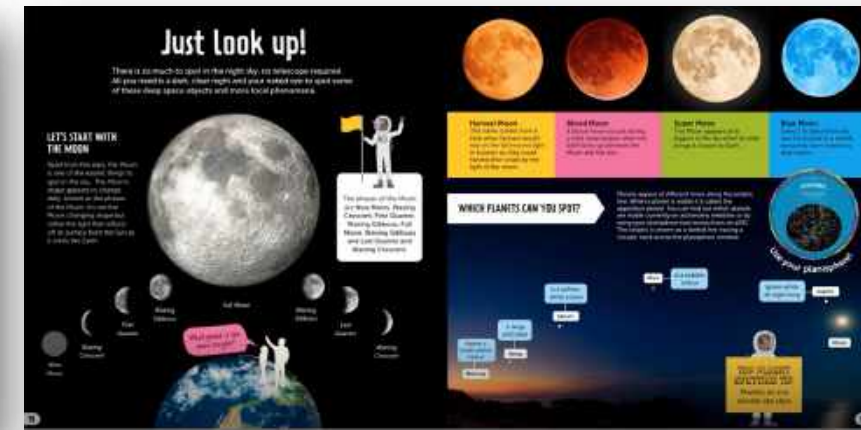

Link to presentation/full pages:
[Discover the Night Sky](#)

First 50 Facts series

- A collection of 50 fascinating and indispensable facts to awaken children's curiosity about the variety of the world.
- Five spreads themed by habitat, each with five flaps to lift that tell a story or add to the facts underneath.
- Beautiful and stylish artwork that will make readers want to spend time exploring every page.

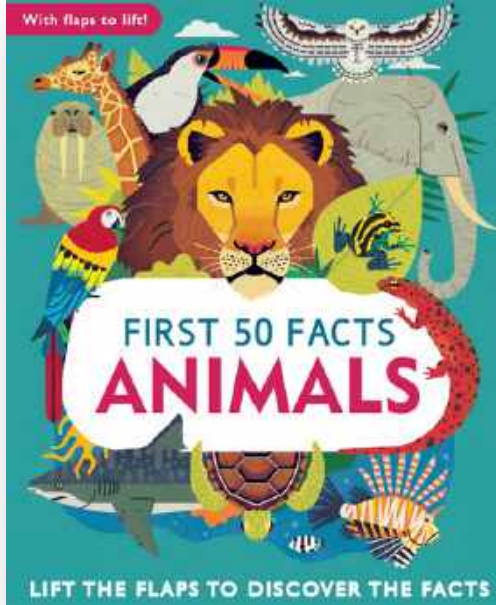

Extent: 12 pages

TPS (h x w): 307mm x 247mm

Translation files available: Now

RRP: £15.99

Links to presentation/full pages:

[First 50 Facts Animals - Video](#)

[First 50 Facts Dinosaurs](#)

[First 50 Facts Machines](#)

[First 50 Facts Human Body](#)

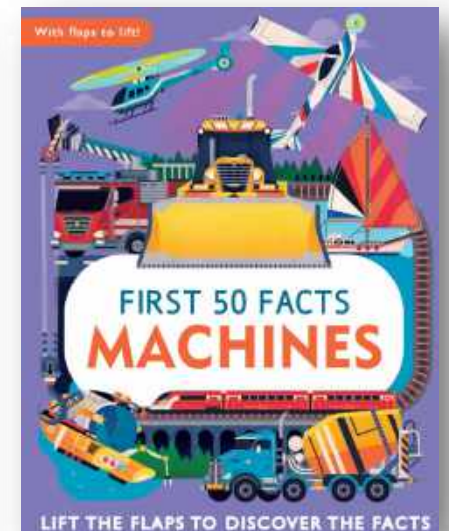
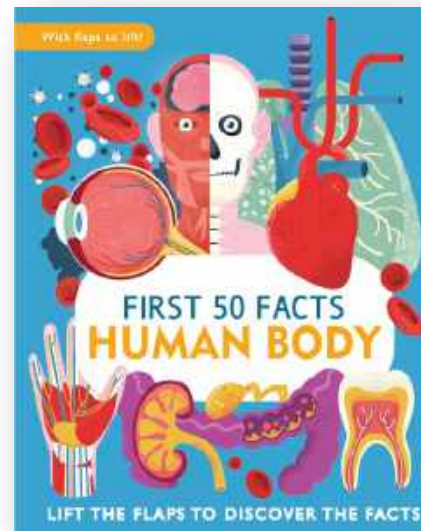

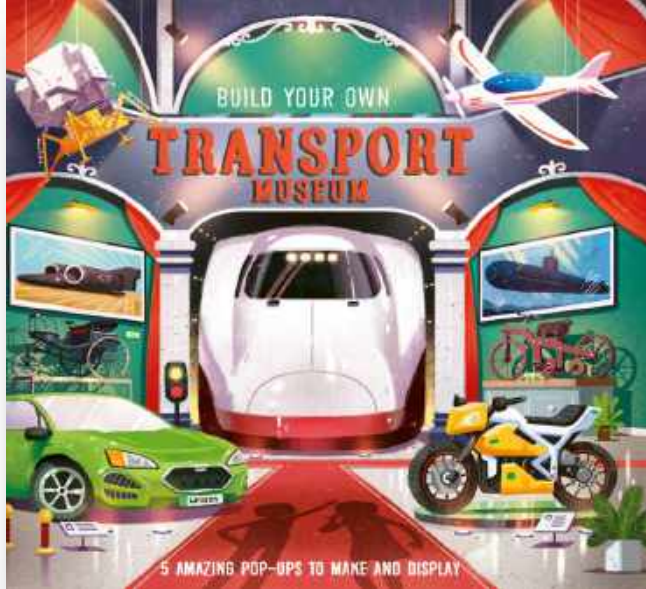

Build Your Own Transport Museum

- This hands-on, build-it-yourself STEAM approach to transport technology imagines the reader as a curator who must build amazing objects and place exhibits in their transport museum.
- Includes an “exhibits crate” section that contains pre-kiss cut sheets for 5 pop-out models to build in the book, plus additional “exhibits” for the reader to slot in throughout.
- 8 pre-kiss cut card sheets to make 5 pop-out objects and multiple page inserts.

Extent: 24 pages

TPS (h x w): 260mm x 281mm

Translation files available

RRP: £14.99

Link to presentation/full pages:

[Build Your Own Transport Museum](#)

[Build Your Own Space Museum](#)

[Build Your Own Science Museum](#)

[Series A1](#)





Journey Through Series

- Travel through space with the astronauts and discover what's behind every hatch. Learn about astronaut training, what happens at Mission Control, and how a rocket launches into space.
- Die-cut holes lead the reader through the space scenes, and flaps on every page entice the reader to discover more.
- Spotting activities on every page will engage even the most reluctant readers.

Extent: 14 pages

TPS (h x w): 300mm x 240mm

Translation files available

RRP: £19.99

Link to presentation/full pages:

[Journey Through Space](#)

[Journey Through The Ocean](#)

[Journey Around the World](#)

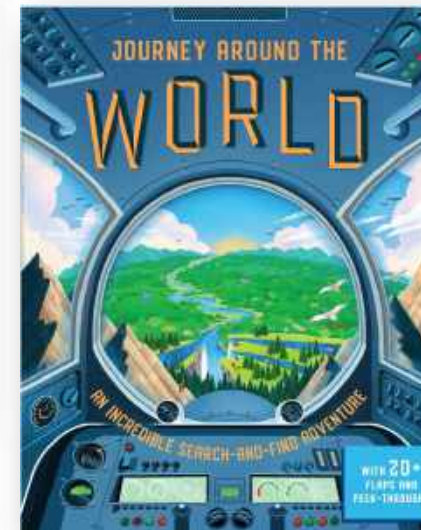



Magic Flashlight Jungle & Magic Telescope Space

- Children will love exploring the jungle and space after dark with this revealing series. Use the die-cut mechanism to illuminate different dark scenes.
- Packed with information, humour and beautifully vivid illustrations.



Extent: 24 pages
 TPS (h x w): 320 x 236mm
 Translation files available
 RRP: £14.99

Link to presentation/full pages:
[Magic Flashlight Jungle](#)
[Magic Telescope Space](#)



Dig/Dive and Discover

- Young archeologists will love to explore detailed, busy scenes from history, then get hands-on with the scratch off layers.
- Spot ancient objects in bustling scenes from history, then uncover those same items thousands of years later, on an archaeological dig.
- Find precious jewels, famous artefacts and prehistoric fossils and more, in this young history series.

Extent: 26 pages

TPS (h x w): 300mm x 232mm

Translation files available

RRP: £18.99



Link to presentation/full pages:

Dig and Discover Ancient History: [PDF](#) - [video](#)

Dig and Discover Dinosaurs: [PDF](#) - [video](#)

Dive and Discover: Deep Dark Sea

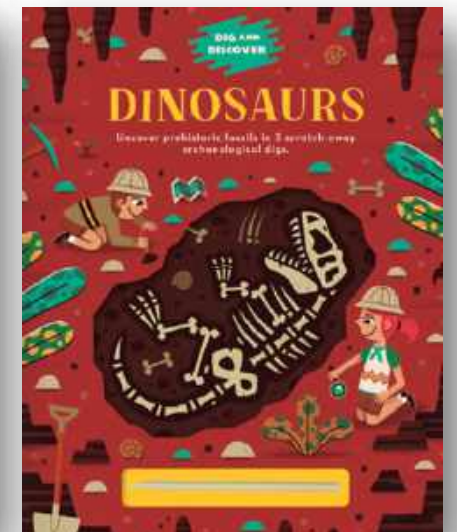

Listen to the Music

- Press the buttons to hear the music in this time-travelling journey around the world, as young readers embark on a magical adventure through the history of music!
- Stopping off at 10 key chronologically organised moments in history, in different places around the world, readers meet a great musician in each, and can press their instruments to hear a clip of their musical masterpieces!
- Already sold in 7 languages, this is the first volume of a brand new sound book series inspired by our best-selling *Story Orchestra* series.

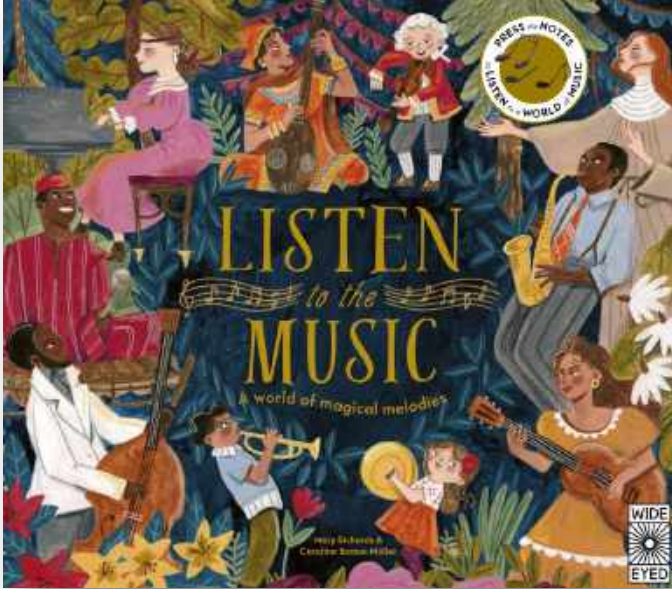

Extent: 24 pages + 10 sound clips

TPS (h x w): 265mm x 304mm

Translation files available: available

Retail price: £16.99

Link to presentation/full pages:

[Listen to the Music Sounds + Video](#)





Listen to the Music – The Instruments

Written by Mary Richards and illustrated by Khoa Le

- Following on from the beautiful Listen to the Music comes a new adventure. This time, Pip and Sammy hear music composed for 10 of the most beloved instruments in the orchestra, from Elgar's Cello Concerto to Tchaikovsky's Concerto in D Major for violin.
- Each of the ten composers throughout the story will tell the children about their favourite instrument, how it makes them feel, and what animals or moods it made them think of as they were writing the piece of music.
- Children will enjoy pressing the buttons and hearing the music as they listen to the gentle narrative. This is a beautiful first introduction to the history of music as told to the tune of the key instruments in the orchestra.
- Next in the series – Christmas!



Extent: 24 pages + 10 sound clips

TPS (h x w): 265mm x 304mm

Translation files: available

Retail price: £16.99

Next co-edition schedule

File to printer: 01 August 2024

Delivery FOB: 01 December 2024

Link to presentation/full pages:

[Listen to the Music - The Instruments](#)





Sounds of Nature

- A 2019 Outstanding Science Trade Book for Students: K–12 (National Science Teachers Association and the Children's Book Council).
- Travel the world with the Sounds of Nature series – press the note in each of the 10 habitats to hear vivid recordings of over 60 different bird sounds.



Extent: 24 pages + 10 sound clips
TPS (h x w): 265mm x 304mm
Translation files available: available
Retail price: £16.99

Link to presentation/full pages:
[Sounds of Nature series](#)

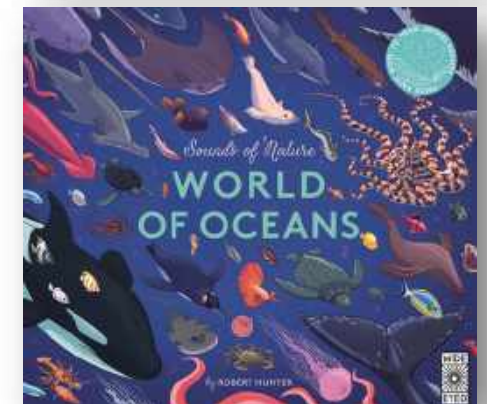
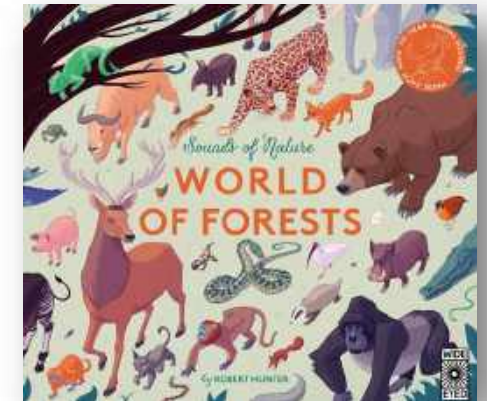

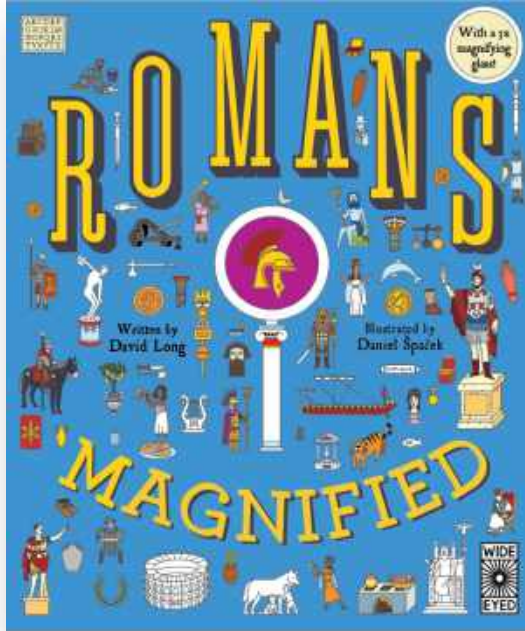

Magnified series

Written by David Long and illustrated by Daniel Špacek

- Grab your magnifying glass and travel back in time in these search-and-find adventures. The series includes: *Ancient World*, *Egypt*, *Pirates*, *Castles* and the latest addition – *Romans!*
- Learn what life was like for them – from the seven hills to the Colosseum and beyond. Discover what really happened in a typical Roman market, temple, school and villa with authentic detail and cutaway scenes to unearth thanks to your own clever little 3x magnifying glass.
- A Wide-Eyed classic best-seller with over 120,000 copies sold in foreign languages worldwide!

Extent: 48 pages + magnifying glass

TPS (h x w): 310mm x 256mm

Translation files: available

Retail price: £16.99

Link to presentation/full pages:

[Romans Magnified](#), [Pirates Magnified](#), [Castles Magnified](#)
[Video](#)

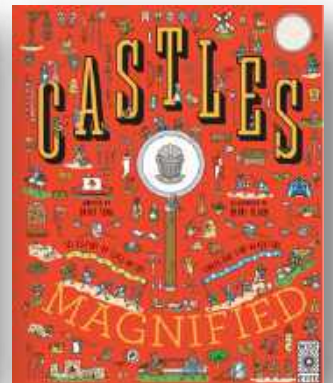
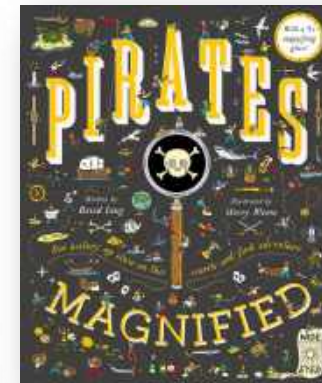
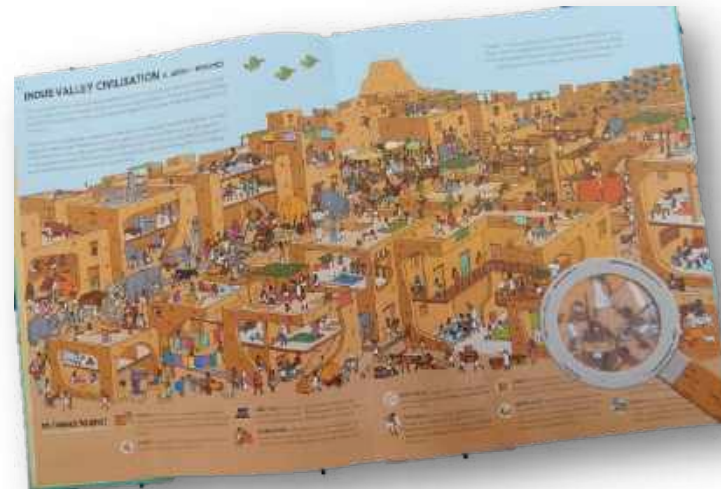

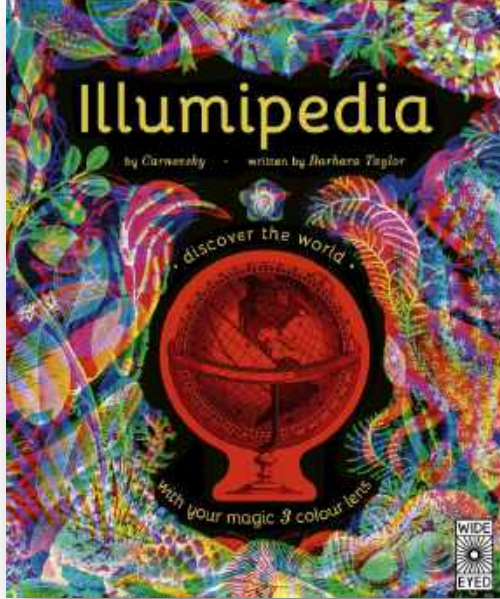

Illumi... series

Written by Barbara Taylor and illustrated by Carnovsky

- Latest in the Illumi series is the awe-inspiring *Illumipedia*!
- In *Illumipedia*, discover animals, insects, dinosaurs and the ocean deeps with your three-colour lens as you explore the world and its natural phenomena like never before.
- Bringing together content from five books in the iconic Illumi series, this new treasury spans the best of Nature, Oceans, Bugs and Dinosaurs – across six continents. Each spectacular artwork is really three images in one: use the magic lens to reveal different layers to the environment you're in.
- This is the latest instalment in the 'illumi' series which has performed exceptionally well both in English language markets and internationally, selling in over 20 languages. Previous titles in the series: *Illuminature*, *Illuminatlas*, *Illumanatomy*, *Illuminightmare*, *Illumisaurus*, *Illumibugs* & *Illumioceans*!

Extent: 160 pages + 3-colour lens

TPS (h x w): 340mm x 280mm

Translation files: April 2024

Retail price: £20.00

Link to presentation/full pages:

[Illumipedia](#)

[Illuminocean](#), [Illumibugs](#), [Illumisaurus](#),

[Illuminightmare](#)

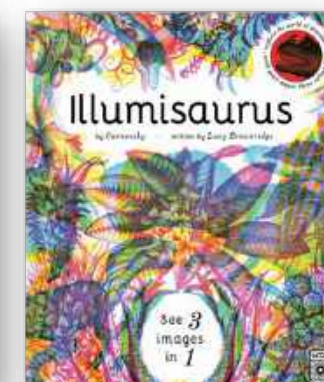
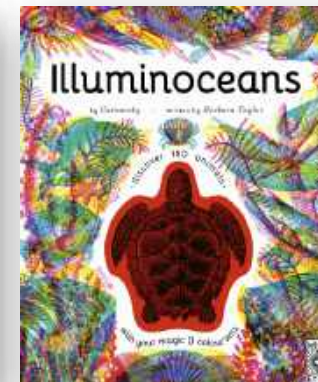
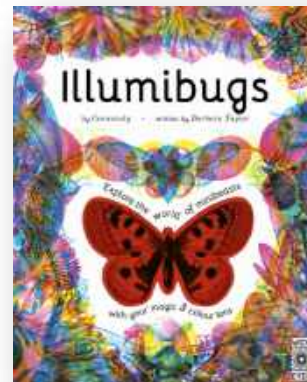

Quarto